



Design guide

Modbus Interface DIII

Design guide Modbus Interface DIII EKMBDXB7V1

Table of Contents

Safety Precautions	3
1. Introduction	3
1.1 System layout	3
1.2 Limitations	4
1.3 Specifications	4
1.3.1 Dimensions and field wiring	5
1.3.2 Wiring diagram	6
1.3.3 LED meaning	6
1.3.4 Termination resistance (SS switches)	6
1.3.5 Push buttons	7
1.3.6 Dipswitch meaning	7
1.4 Overview of compatible Daikin units ranges with DIII connection	8
1.5 Overview of compatibility with other DIII centralised control equipment	8
2. Modbus communication	10
2.1 Modbus Interface DIII settings	10
2.2 Communication format	11
2.2.1 Function format	11
2.2.2 Character format	14
2.2.3 Silent internal time	14
2.2.5 Response time	14
2.3 Communication procedure	15
2.3.1 System initialisation	15
2.3.2 Monitor and operate units from the BMS	16
2.3.3 Other DIII devices exist in the same system	20
3. Modbus registers	21
3.1. Input registers	21
3.2 Holding registers	32
4. Software of Modbus Interface DIII	40
4.1 Software releases	40
4.2 Software update with Updater	40
4.2.1 Updater	40
4.2.2 Method 1) Update with the PC USB cable EKPCAB*	41
4.2.3 Method 2) Update with a USB/RS485 converter	43
5. Modbus Interface DIII test operation	45

5.1 Introduction.....	45
5.2 Outline of system.....	45
5.3 Test Operation Procedure	46
5.3.1 Prepare register groups	46
5.3.2 Start reading registers groups	49
5.3.3 Set a holding register	50
6. Troubleshooting.....	51
7. Revision of the document.....	52

Safety Precautions

Before performing design, construction, or maintenance thoroughly, read the “Safety Precautions” in the installation manual provided with the product.

1. Introduction

A Building Management System (BMS) can control Daikin units through the Modbus protocol by using the *Modbus Interface DIII* EKMBDXB7V1.

Glossary:

- BMS: Building Management System
- DIII unit: Unit with DIII communication connected to the Modbus Interface DIII.
- DIII device: A centralised device from Daikin with DIII communication (e.g. iTM, ...)
- Indoor unit: As the main target is to monitor and control VRV connected indoor units, the DIII units are referred to as *indoor units*. For some systems the connected DIII units are in reality outdoor units (e.g. Applied units)

1.1 System layout

Typical setup (e.g. VRV)

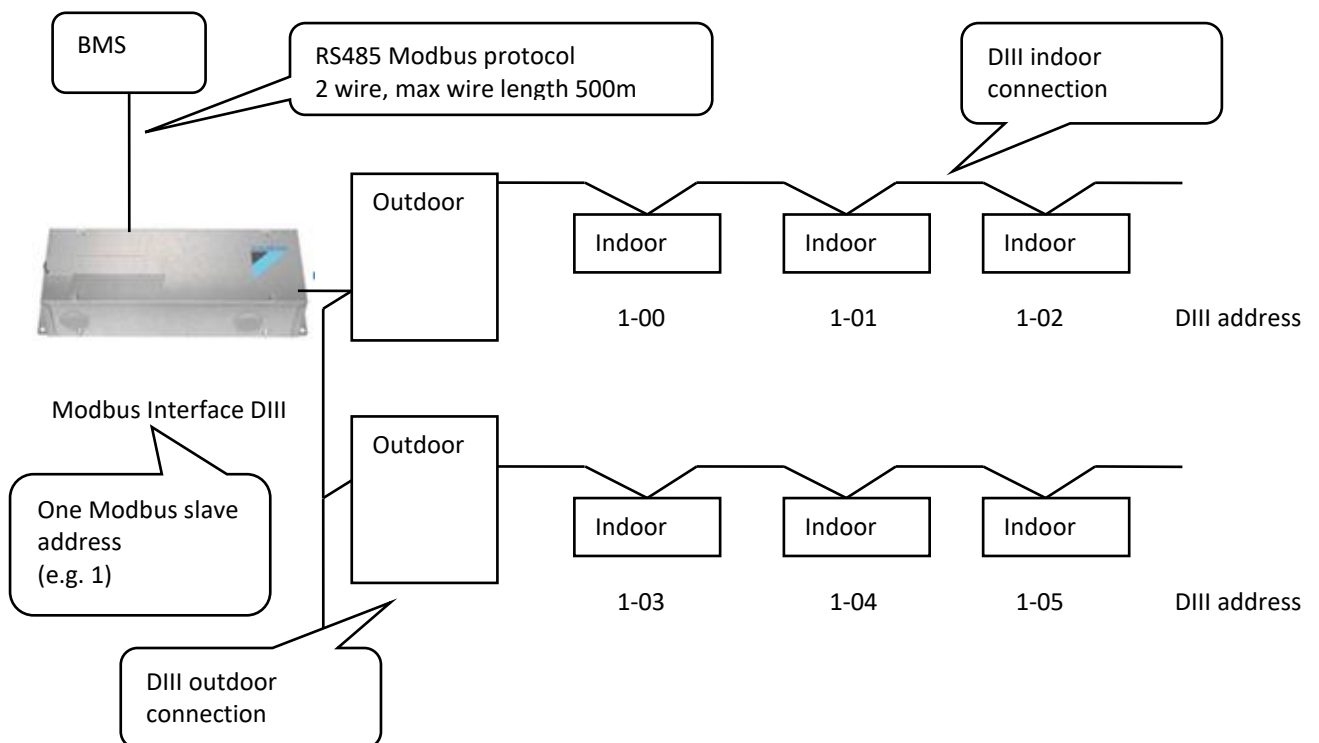

DIII address (Group NO) needs to be set on an individual indoor unit or group by the connected user interface. Functions of each Indoor unit in a range for each register:

Example:

Register address	DIII address functions
31001 – 31003	1-00
31004 - 31006	1-01
...	...

1.2 Limitations

The number of control commands per indoor unit is limited to 7000 per year.

If the BMS controls the units by using an automatic control program, please make sure it doesn't exceed this limitation.

1.3 Specifications

Daikin equipment connection	DIII net (F1F2) maximum 64 indoor units (groups) and maximum 10 outdoors (addr 1-00 till 4-15)
BMS equipment protocol	Modbus RS485 (2 wire, max 500m)
Installation place	Indoor installation
Operation condition	Temp range 0 till 60°C
Dimensions	379 x 87 x 124 mm
Mass (Weight)	2,1 kg
Power supply	220 – 240 VAC 50 Hz
Software	The <i>Modbus Interface DIII</i> software can be updated with the <i>Daikin Updater</i> PC software Refer to chapter "4.2 Software update with Updater" for details.
Installation manual	Provided with the option
Design guide	Latest version available on: http://www.daikineurope.com/support-and-manuals/product-information

1.3.1 Dimensions and field wiring

Refer to installation manual

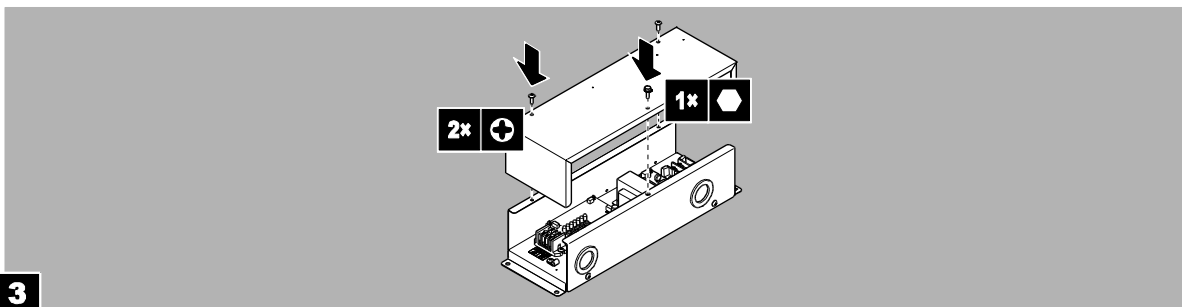
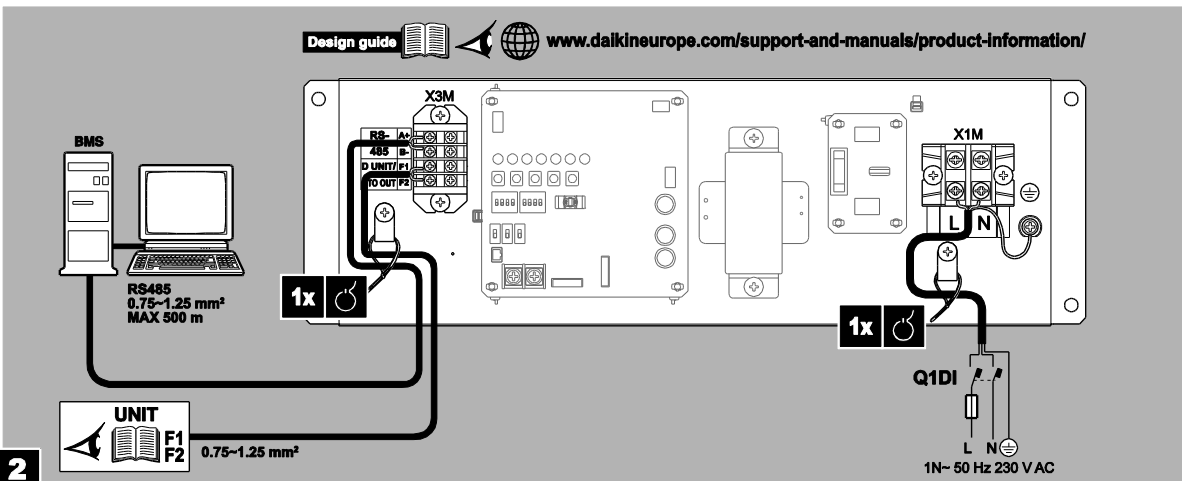
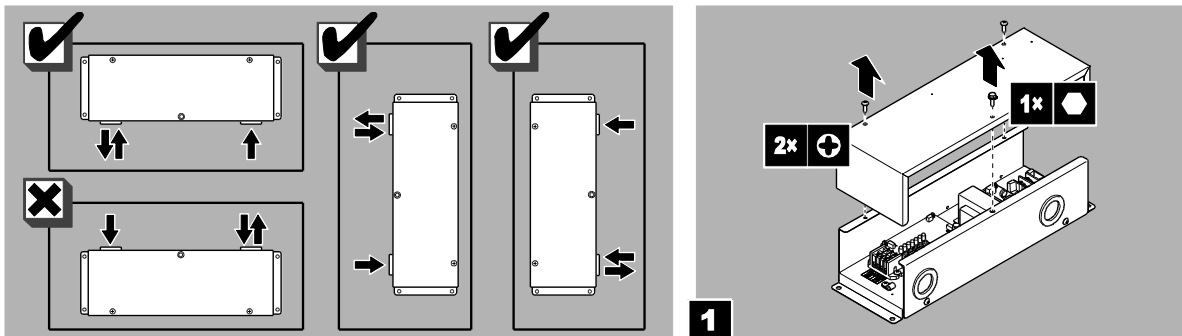
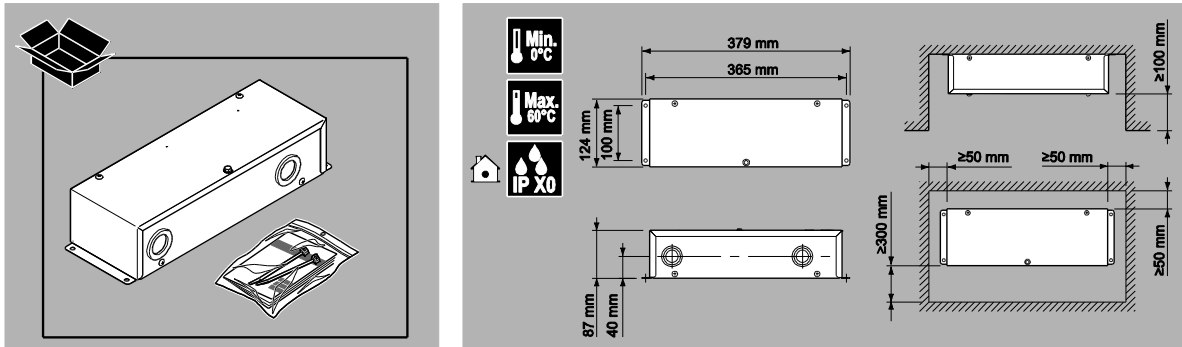

1.3.2 Wiring diagram

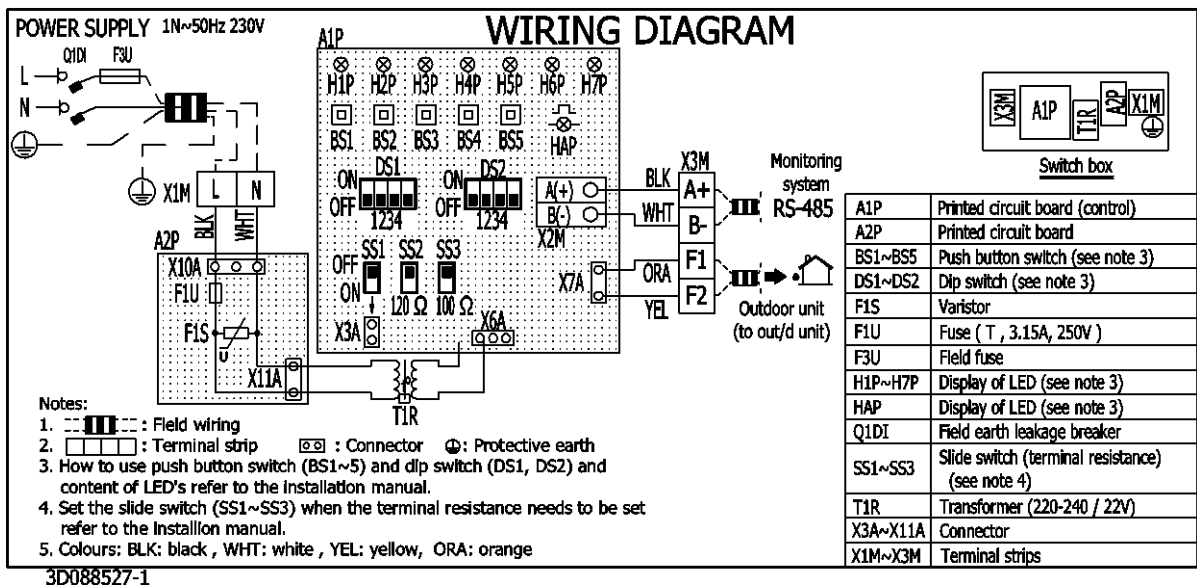

1.3.3 LED meaning

During normal operation (application is running):

- H1P: DIII communication (sent)
- H2P: DIII communication (receive)
- H3P: RS485 communication (sent)
- H4P: RS485 communication (receive)
- H5P H6P H7P: no meaning
- HAP: blinking at 400ms = application is running

During uploading of new software (firmware is running)

- H1P till H7P: Progress indication (0 till 100%)
- HAP: blinking at 200ms = firmware is running.

1.3.4 Termination resistance (SS switches)

By factory default the termination resistance is 0 Ohm (SS2=Off & SS3 =Off)

- SS2 On = 120 Ohm
- SS3 On = 100 Ohm
- (SS2 = On & SS3 = On, not allowed)

Please slide the SS2 or SS3 to the ON position to set required termination resistance value of the RS485 line.

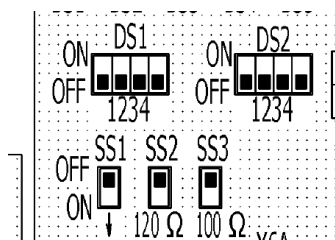

Remark: SS1: not used.

1.3.5 Push buttons

BS1 till BS5 have no meaning

1.3.6 Dipswitch meaning

Attention: Dipswitch on/off status is detected during power on of the PCB only. A power reset is needed after setting the switches.

Dipswitch DS1 & DS2 setting:

RS485 Modbus communication speed	
DS1 pin 2:Off	9600 bps
DS1 pin 2:On	19200 bps
Modbus communication parity / stop bit	
DS1 pin 3:Off 4:Off	Even 1 stop bit
DS1 pin 3:Off 4: On	Odd 1 stop bit
DS1 pin 3:On 4:Off	None 2 stop bit
DS1 pin 3:On 4:On	None 1 stop bit
Modbus address setting	
DS2 pin 1/2/3/4	When Modbus address is set (eg 1..15), then modbus RS485 communication is enabled.
Off/Off/Off/Off	No Modbus address is set, meaning no modbus RS485 communication
Off/Off/Off/On	Address 1
Off/Off/On/Off	Address 2
...	
On/On/On/On	Address 15

Attention:

During software upload with updater PC program via RS485 port a specific dipswitch setting is required. Refer to chapter "4.2.3 Method 2) Update with a USB/RS485 converter." for details.

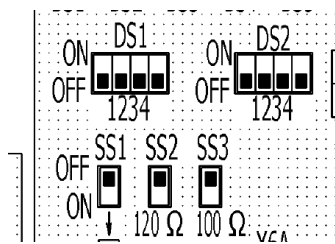

Remark: DS1 – pin 1: not used.

1.4 Overview of compatible Daikin units ranges with DIII connection

For compatibility with a specific model, please check the manual of the corresponding model. Updates of the software will be available on the Business Portal (maintenance by Service)).

Product overview:

- SKY (F1,F2)
- VRV (F1,F2)
- RA (via KRP928)
- VAM / VKM
- EKVDX
- VRV Hydro Box
- Air curtains
- ERQ-Control box (connection to 3rd party AHU)
- Heating
- Applied

1.5 Overview of compatibility with other DIII centralised control equipment

		Intelligent Touch Manager	Interface for use in LonWorks®	Interface for use in BACnet®	Intelligent Touch Controller	Intelligent Tablet Controller	Residential central remote controller	Central Remote controller	Unified ON/OFF controller	Schedule timer (*1)
		DCM601A51	DMS504B51	DMS502B51	DCS601C51	DCC601A51	DCS303A51	DCS302CA61	DCS301BA61	DST301BA61
DIII Modbus interface	EKMBDXB7V1	OK	NG	NG	OK	NG	NG	OK	OK	NG

(*1): The schedule timer should be used in combination with the central remote controller or unified ON/OFF controller

- If using in combination with centralized control equipment, the relation between both central remote controllers is last command priority.

- if using in combination with centralized control equipment, the remote control mode is decided by the setting of the highest priority item in the priority rank.

Priority ranking of Modbus Interface DIII:

No priority ranking is implemented. Meaning, in case another D-BACS device is detected, the lock button & force OFF functions are not available.

2. Modbus communication

2.1 Modbus Interface DIII settings

Communication protocol	Modbus RTU (according to “Modicon Modbus Protocol reference guide” PI-MBUS-300 Rev J)	Dipswitch setting
Communication speed	9600 bps Or 19200 bps	DS1 pin 2:Off DS1 pin 2:On
Parity / stop bit	Even 1 stop bit Odd 1 stop bit None 2 stop bit None 1 stop bit	DS1 pin 3:Off 4:Off DS1 pin 3:Off 4: On DS1 pin 3:On 4:Off DS1 pin 3:On 4:On
One dedicated modbus address setting	1..15	DS2 pin 1/2/3/4 Addr 1: Off/Off/Off/On Addr 2: Off/Off/On/Off ... Addr 15: On/On/On/On
Implemented function codes	0x03 Read Holding Registers (broadcast support) 0x04 Read Input Registers (broadcast support) 0x06 Preset Single Registers (No broadcast support) 0x10 Preset Multiple Registers (No broadcast support) (remark: Holding Registers will not reflect the actual value) (other function codes are treated as illegal function and return an exception response)	
Data types	Input Register: Length 16 bits, Address range: 30001 - 39999 Holding Register Length 16 bits, Address range: 40001 – 49999 (Data larger than 16 bits can be handled by assigning continuous addresses to registers.)	
Register addresses	Same address meaning for each applicable model	

2.2 Communication format

2.2.1 Function format

(1) Read Input Registers (0x04)

[Function]

Read values of input registers. The address and the content of input registers are described in

3. Modbus registers

[Query]

The query message specifies the start address of the register and the number of registers. The register address starts at zero: register 30001 is addressed as 0.

This function can read up to 32 registers in one query.

Here is an example of a request to slave address 1 for reading 3 register values starting from register 31001.

Query	
Field	Data
Slave Address	0x01
Function Code	0x04
Start Address(Upper)	0x03
Start Address(Lower)	0xE8
Number of Registers(Upper)	0x00
Number of Registers(Lower)	0x03
Error Check CRC16(Lower)	0x30
Error Check CRC16(Upper)	0x7B

Response	
Field	Data
Slave Address	0x01
Function Code	0x04
Data Size(Bytes)	0x06
Data1(Upper)	0xXX
Data1(Lower)	0xXX
Data2(Upper)	0xXX
Data2(Lower)	0xXX
Data3(Upper)	0xXX
Data3(Lower)	0xXX
Error Check CRC16(Lower)	0xXX
Error Check CRC16(Upper)	0xXX

(2) Preset Single Register (0x06)

[Function]

Write a value to a holding register. In case of broadcast, the value is written to the same holding register of all slave units. The address and the content of the holding registers are described in

3. Modbus registers

[Query]

The query message specifies the start address of the register and a value. The register address starts at zero: register 40001 is addressed as 0. Here is an example of a request to slave address 1 for writing the value '2' to register 42002.

Query	
Field	Data
Slave Address	0x01
Function Code	0x06
Address(Upper)	0x07
Address(Lower)	0xD1
Value(Upper)	0x00
Value (Lower)	0x02
Error Check CRC16(Lower)	0x59
Error Check CRC16(Upper)	0x46

Response	
Field	Data
Slave Address	0x01
Function Code	0x06
Address(Upper)	0x07
Address(Lower)	0xD1
Value(Upper)	0x00
Value (Lower)	0x02
Error Check CRC16(Lower)	0x59
Error Check CRC16(Upper)	0x46

(3) Preset Multiple Registers (0x10)

[Function]

Write values to holding registers. In case of broadcast, the values are written to the same holding registers of all slave units. The address and the content of holding registers are described in

3. Modbus registers

[Query]

The query message specifies the start address of the register, size of data and values. The register address starts at zero: register 40001 is addressed as 0. This function can write up to 30 registers in one query. Here is an example of a request to slave address 1 for writing 2 values to register 42001 and to register 42002.

Query	
Field	Data
Slave Address	0x01
Function Code	0x10
Start Address(Upper)	0x07
Start Address(Lower)	0xD0
Number of Registers(Upper)	0x00
Number of Registers(Lower)	0x02
Data Size(bytes)	0x04
Value1(Upper)	0x00
Value1(Lower)	0x10
Value2(Upper)	0x00
Value2(Lower)	0x01
Error Check CRC16(Lower)	0x18
Error Check CRC16(Upper)	0xC6

Response	
Field	Data
Slave Address	0x01
Function Code	0x10
Start Address(Upper)	0x07
Start Address(Lower)	0xD0
Number of Registers(Upper)	0x00
Number of Registers(Lower)	0x02
Error Check CRC16(Lower)	0x41
Error Check CRC16(Upper)	0x45

(4) Exception response

In case the query message is faulty, the *Modbus Interface DIII* will reply an exception response. In normal conditions the function code of the response message is the same as the query message. But in case of an error, 0x80 is added to the function code of the response message.

The exception response includes the exception code, indicating the cause of the error.

Exception code	Name	Cause
0x01	Illegal function	This function code is not supported.
0x02	Illegal data address	Access was attempted to an unassigned register address.
0x03	Illegal data	This query includes unauthorized data.

[Example of exception response]

In the case of setting an illegal mode to the holding register address 42002.

Query	
Field	Data
Slave Address	0x01
Function Code	0x06
Start Address(Upper)	0x07
Start Address(Lower)	0xD1
Number of Registers(Upper)	0x01
Number of Registers(Lower)	0x0F
Error Check(Lower)	0x99
Error Check(Upper)	0x13

Response	
Field	Data
Slave Address	0x01
Function Code	0x86
Exception Code	0x03
Error Check(Lower)	0x02
Error Check(Upper)	0x61

2.2.2 Character format

Each byte of a message is sent as character data as follows.

A character consists of start bit (0), 8 bits data, parity bit and stop bit (1). One character size is always 11 bits and stop bit 1 or 2 is selected by parity bit.

[Non Parity]

0 (LSB)	1	2	3	4	5	6	7	8	9	10 (MSB)
Start bit	Data								Stop bit 1	Stop bit 2

[Parity]

0 (LSB)	1	2	3	4	5	6	7	8	9	10 (MSB)
Start bit	Data								Parity bit (Odd or Even)	Stop bit 2

2.2.3 Silent interval time

Every frame needs to have silent interval time (T1-T2-T3-T4) before and after. The silent interval time is depending on communication speed.

Baud Rate(bps)	9600	19200
Silent Interval Time(ms) (T1-T2-T3-T4)	5	2,5

2.2.5 Response time

This *Modbus Interface DIII* responds a message after response time(t1) when this *Modbus Interface DIII* receives a query message. The response time(t1) of this adaptor is "Silent Interval Time(T1-T2-T3-T4) + 20ms". Modbus master needs to wait to send next query message for time interval(t2) when the modbus master receives a response from the *Modbus Interface DIII*. The time interval(t2) should be more than "Silent Interval Time(T1-T2-T3-T4) + 20ms".

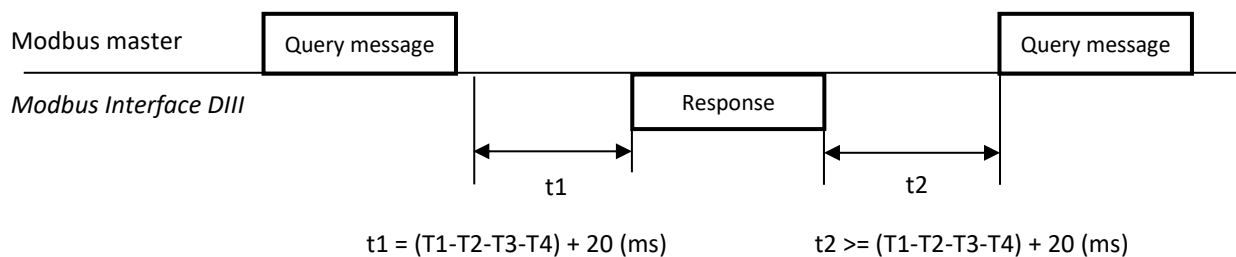

2.3 Communication procedure

2.3.1 System initialisation

At startup:

- All input registers have values 0.

After the discovery of the DIII connected units, the "DIII unit connected status bit" (see Input registers 30002 till 30006) will be updated to "1: connected" and the input registers of the connected DIII units (30001 and higher) will have the correct values.

- All the holding registers have initial values 0.

After the discovery of the DIII connected units, the "DIII unit connected status bit" (see input registers 30002 till 30006) will be updated to "1: connected" and the holding registers of the connected DIII units (42001 and higher) will be updated to the actual values once.

Attention: The holding values receive the actual values at the detection time only. This means this will only happen once. (Remark: also not during rediscovery)

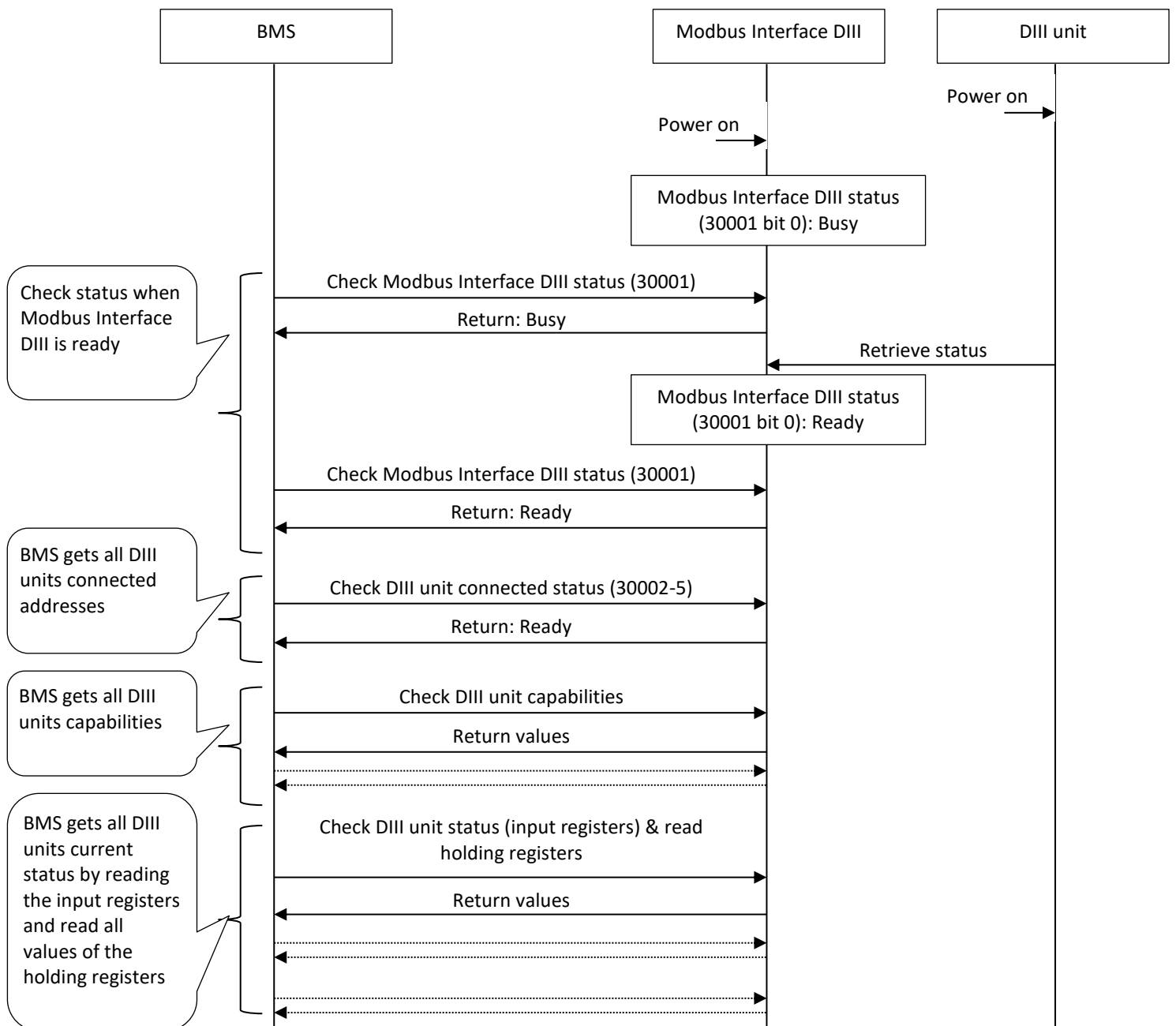

2.3.2 Monitor and operate units from the BMS

Input registers of each DIII unit: 30001 and higher

The input registers will contain the status of the connected DIII units.

In case the DIII communication is interrupted (see Input registers 30006 till 30009): then the last communicated values will remain, until the DIII communication is restored.

Status changes are communicated continuously to the input registers, meaning the input registers will contain the actual values.

Holding registers of each DIII unit: 42001 and higher

- Writing instructions to change a unit status (Preset Single or Multiple Registers)

When a value is written to a holding register, it will be communicated to the DIII units.

Attention: *Modbus Interface DIII* sends the command to a unit when the value of a Holding Register is changed. Especially in case that indoor units are operated from the user interface, the BMS should always get the status of indoor units and copy the received status to the Holding Registers.

Note: at start-up of the system (See 2.3.1 System initialisation) and the initial discovery of the DIII connected units, the *Modbus Interface DIII* put the actual status in the holding registers. (Remark: not during rediscovery.)

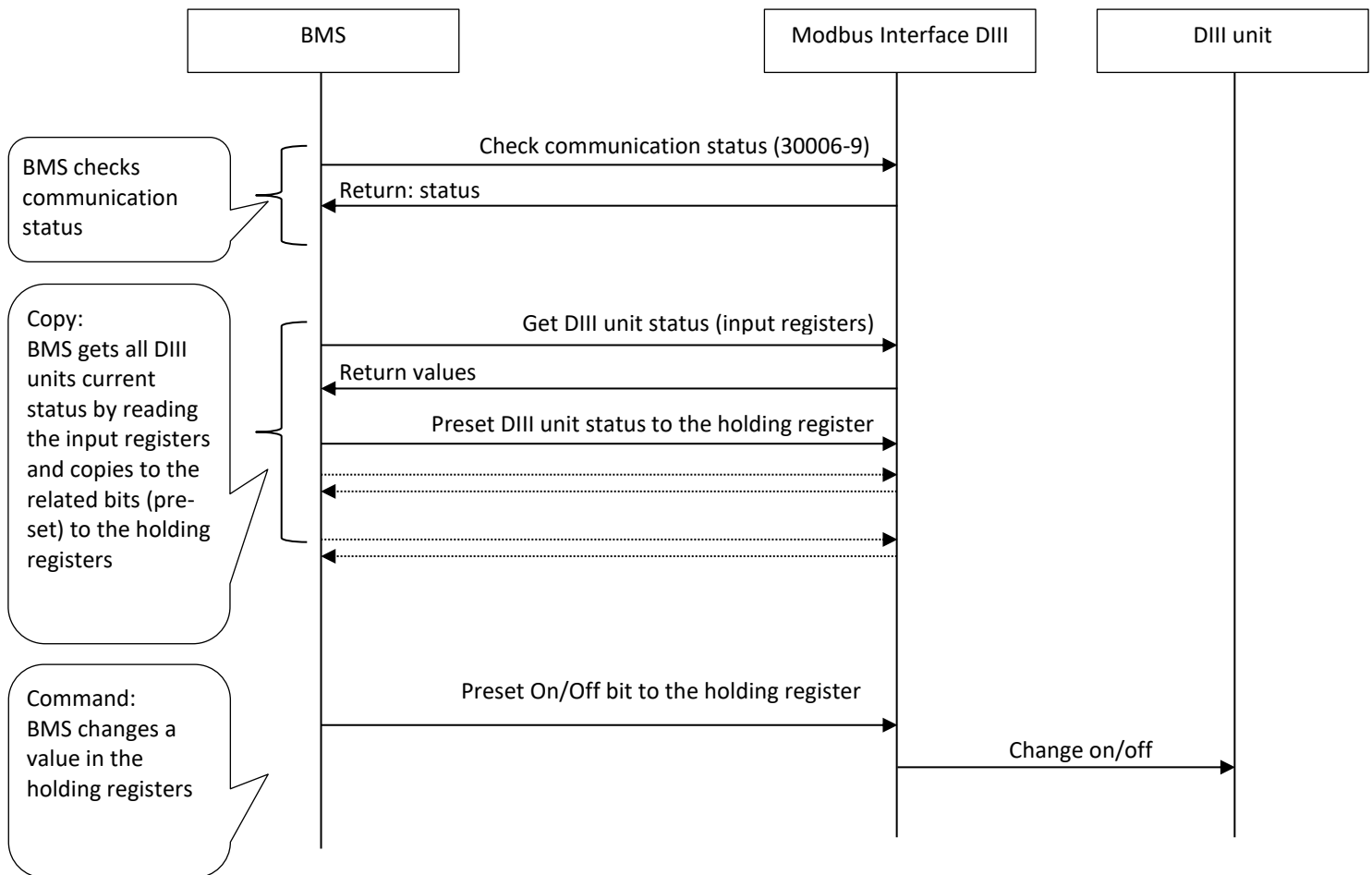

Step by step explanation of the required copy of the BMS.

Below is an example for On/Off operation.

Note: The interval setting to the same register is over 0.5s.

[Legend]

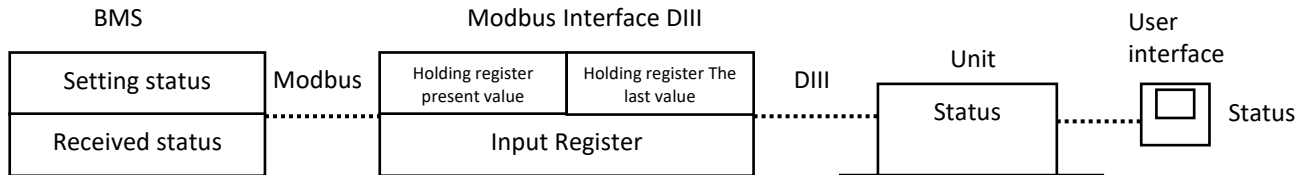

[On/Off operation sequence example]

1. The BMS receives the Off status of units (1) and copies the input status to Holding registers (2).

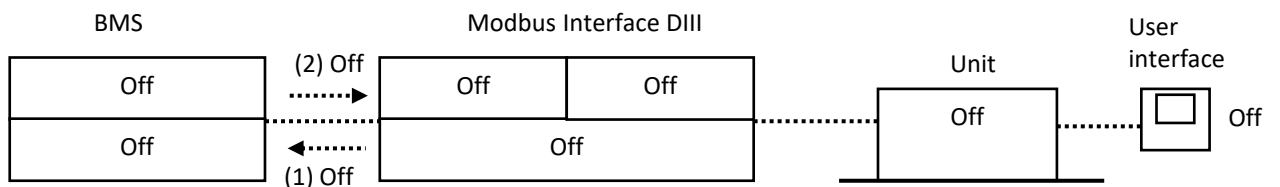

2. The BMS sends an On command to the unit.

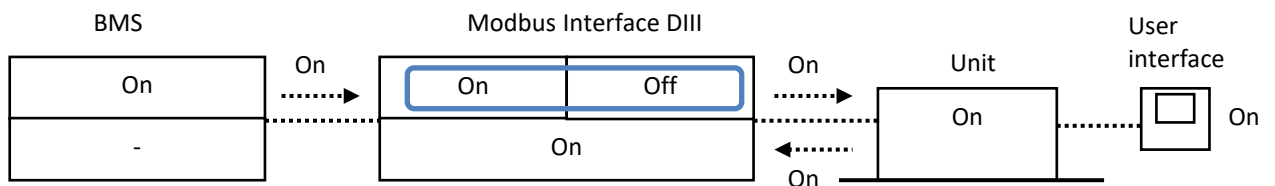

The value of the holding register is changed. So the Modbus Interface DIII sends the command to the units.

3. The BMS gets the status of the input register (1) and copies the received status to the holding registers (2).

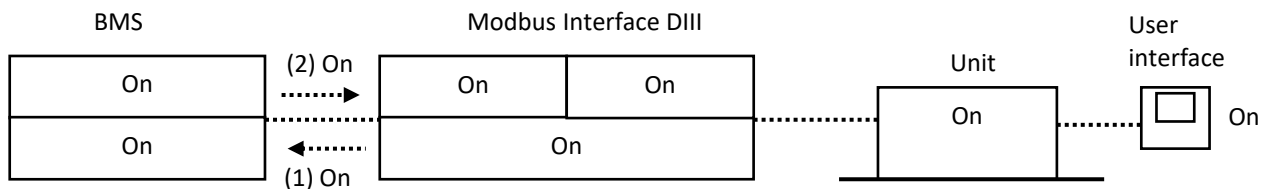

4. The unit is switched Off by the user interface.

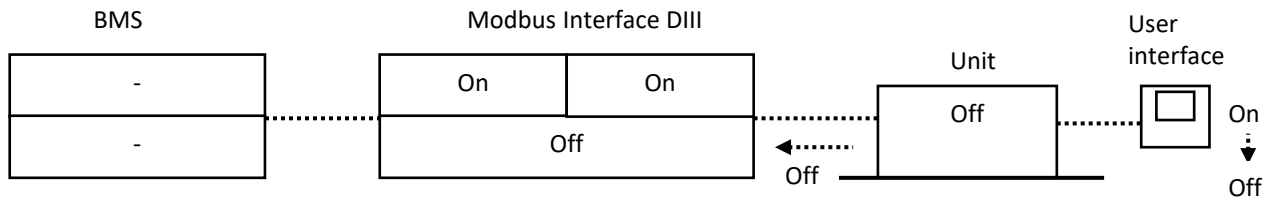

5. The BMS gets the status of the input register (1) and copies the received status to the holding registers (2).

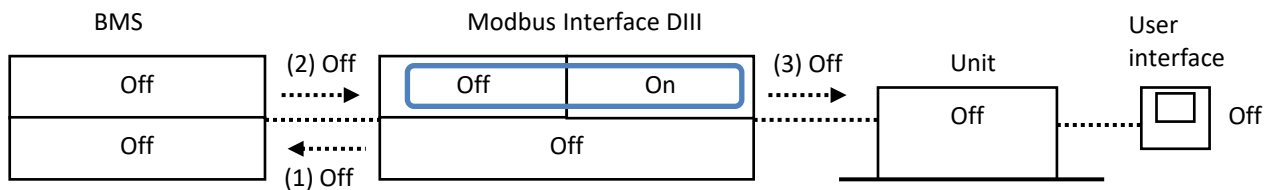

The value of the holding register is changed. So the Modbus Interface DIII sends the command to the units (3).

6. The BMS sends an On command to the unit.

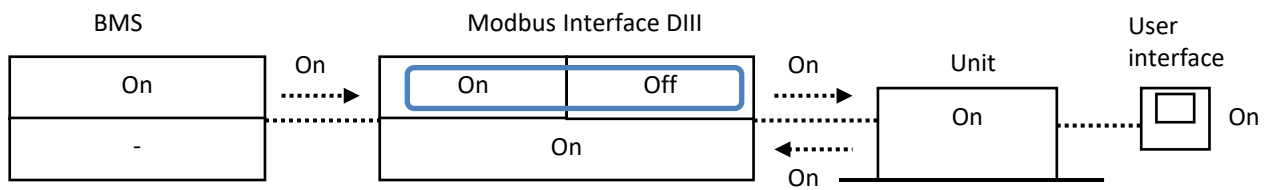

The value of the holding register is changed. So the Modbus Interface DIII sends the command to the units.

7. The BMS gets the status of the input register (1) and copies the received status to the holding registers (2).

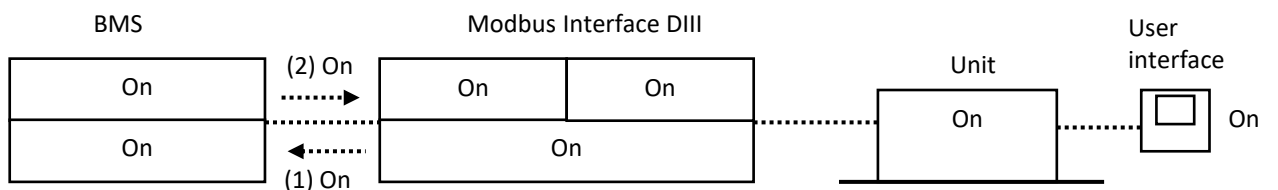

Attention: In case the BMS does not copy (see 5.) and sends an On command to the unit. Then the requested On command will not be executed.

Status

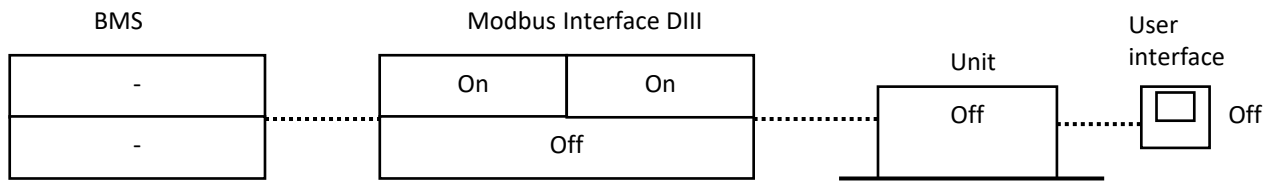

The BMS sends an On command to the unit.

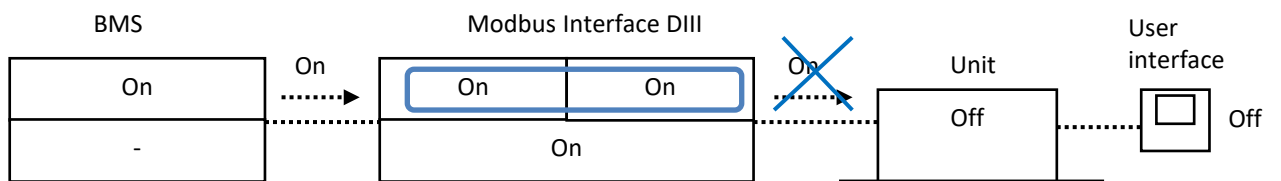

The value of the holding register is not changed. So the Modbus Interface DIII does not send the command to the units.

2.3.3 Other DIII devices exist in the same system

(See 1.5 Overview of compatibility with other DIII centralised control equipment)

No priority ranking is implemented. Meaning in case another DIII device is detected, the lock button & force OFF functions are not available.

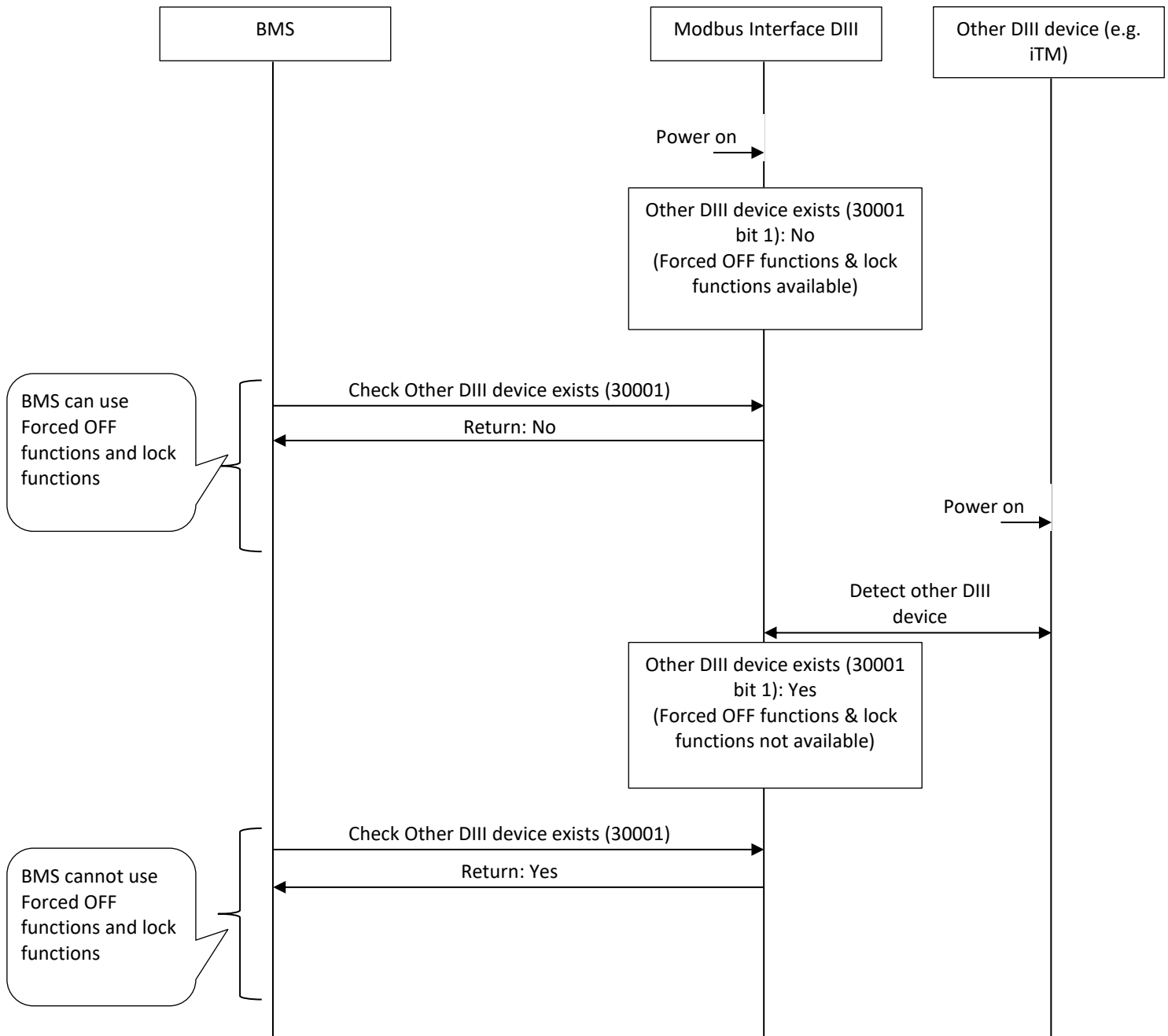

3. Modbus registers

Input registers

30001 till 30009	General <i>Modbus Interface DIII</i> status (incl. Detected DIII units & communication status of DIII units)
31001 and higher	Individual DIII units information

Holding registers

41001	<i>Modbus Interface DIII</i> central "forced off"
42001 and higher	Individual DIII units instructions

Calculation method for input & holding registers of each connected DIII group address:

DIII group address has an "upper address" and a "lower address".

Example for 1-00: "1" is the upper address, "00" is the lower address.

Register of a DIII group address: $\text{Base register} + ((\text{upper address} - 1) * 16 + \text{lower address}) * \text{step}$

E.g. capability input register for 4-15: $31001 + ((\text{"4"} - 1) * 16 + \text{"15"}) * 3 = 31190$

3.1. Input registers

Input register	Bit	Description	Meaning	
30001	15..2	-		
	1	Other DIII device exists	0: No 1: Yes	Note: When another DIII device is connected or disconnected to the DIII, it can take up till 10 minutes to update the status of the input register. (Remark: Initially delivered from factory the value is 1)
	0	Modbus Interface DIII status	0: Busy 1: ready	Typical at power on of the option, the DIII communication is started with the connected DIII units. At the end of the communication start up, all the input registers and holding registers have the correct initial values.
30002	15..0	DIII unit connected status	0: not connected 1: connected	DIII address 1-00 (bit 0) till 1-15 (bit 15)
30003	15..0			DIII address 2-00 (bit 0) till 2-15 (bit 15)
30004	15..0			DIII address 3-00 (bit 0) till 3-15 (bit 15)
30005	15..0			DIII address 4-00 (bit 0) till 4-15 (bit 15)
30006	15..0	DIII unit communication status	0: Normal 1: Communication error	DIII address 1-00 (bit 0) till 1-15 (bit 15) Typically when a DIII device is connected once, and then disconnected: it can take up till 10 minutes to discover the communication error.
30007	15..0			DIII address 2-00 (bit 0) till 2-15 (bit 15)
30008	15..0			DIII address 3-00 (bit 0) till 3-15 (bit 15)
30009	15..0			DIII address 4-00 (bit 0) till 4-15 (bit 15)

Input register		VRV	Sky-air	HRV	Split	VRV hydrobox LT & HT	Air curtains	ERQ control box	Heating	Applied
Indoor unit capability	Fan speed capability(*not split) Fan speed levels capability(*not split) Fan direction capability(*not split) Fan direction levels capability(*not split) Dry mode capability Auto mode capability Heating mode capability Cooling mode capability Fan mode capability (*not split)	0	0	-	0*	0	0	0	0	0
31001 (1-00) 31004 (1-01) .. (step of 3) 31190 (4-15)	Bit	Description	Meaning							
	15	Fan speed capability	0:Not exist 1: Exist							
	14	Fan speed steps capability	0 till 7	This value has only meaning if "Fan speed capability" exists 0: -, 1:Fix, 2: 2step, 3: 3 step, 4: 4 step, 5: 5 step, 6: -, 7: -						
	13									
	12									
	11	Fan direction capability	0:Not exist 1: Exist							
	10	Fan direction steps capability	0 till 7	This value has only meaning if "Fan direction capability" exists 0: -, 1:Fix, 2: 2step, 3: 3 step, 4: 4 step, 5: 5 step, 6: -, 7: -						
	9									
	8									
	7	-								
	6	-								
	5	-								
	4	Dry mode capability	0:Not exist 1: Exist							
	3	Auto mode capability	0:Not exist 1: Exist							
2	Heating mode capability	0:Not exist 1: Exist								
1	Cooling mode capability	0:Not exist 1: Exist								
0	Fan mode capability	0:Not exist 1: Exist								

Input register				VRV	Sky-air	HRV	Split	VRV hydrobox LT & HT	Air curtains	ERQ control box	Heating	Applied
Room temperature set point range	Set point of indoor units range *for split: fixed values refer to KRP928BB2S documentation			0	0	-	0*	0	0	0	0	-
31002 (1-00) 31005 (1-01) .. (step of 3) 31191 (4-15)	Bit	Description	Meaning									
	15..8	Unit cooling set point lower limit	- 128 .. 127°C	8 bit signed integer (bit 15= sign)								
	7..0	Unit cooling set point upper limit	- 128 .. 127°C	8 bit signed integer (bit 7= sign)								
31003 (1-00) 31006 (1-01) .. (step of 3) 31192 (4-15)	15..8	Unit heating set point lower limit	- 128 .. 127°C	8 bit signed integer (bit 15= sign)								
	7..0	Unit heating set point upper limit	- 128 .. 127°C	8 bit signed integer (bit 7= sign)								

(Note: Unit set point range is depending on unit e.g. 16 till 32°C.

In some user interfaces, it is possible to change the set point range towards the user e.g. 20 till 30°C.

But these values are independent from the unit set point range. Meaning unit set point range values are not modified. E.g. 16 till 32°C)

Input register				VRV	Sky-air	HRV	Split	VRV hydrobox LT & HT	Air curtains	ERQ control box	Heating	Applied
Indoor unit capability	Leaving water set point exist Low noise capability Space heating capability Reheat capability			-	-	-	-	0	-	-	0	0
31401 (1-00) 31405 (1-01) .. (step of 4) 31653 (4-15)	Bit	Description	Meaning									
	15..6	-										
	5	Reheat capability	0: Not exist 1: exist									
	4	Space heating capability	0: Not exist 1: exist									
	3	-										
	2	Low noise capability	0: Not exist 1: exist									
	1	Leaving water set point exist	0: Not exist 1: exist									
0	-											

Input register				VRV	Sky-air	HRV	Split	VRV hydrobox LT & HT	Air curtains	ERQ control box	Heating	Applied
Leaving water set point range	Leaving water set point range cooling and heating			-	-	-	-	0	-	-	0	0
31402 (1-00) 31406 (1-01) .. (step of 4) 31654 (4-15)	Bit	Description	Meaning									
	15..8	Unit cooling water set point upper limit	- 128 .. 127°C (unity 1°C)	8 bit signed integer (bit 15= sign)								
	7..0	Unit cooling water set point lower limit	- 128 .. 127°C (unity 1°C)	8 bit signed integer (bit 7= sign)								
31403 (1-00) 31407 (1-01) .. (step of 4) 31655 (4-15)	15..8	Unit heating water set point upper limit	- 128 .. 127°C (unity 1°C)	8 bit signed integer (bit 15= sign)								
	7..0	Unit heating water set point lower limit	- 128 .. 127°C (unity 1°C)	8 bit signed integer (bit 7= sign)								

(Note: Unit set point range is depending on unit e.g. 5 till 20°C.

In some user interfaces, it is possible to change the set point range towards the user e.g. 10 till 15°C.

But these values are independent from the unit set point range. Meaning unit set point range values are not modified. E.g. 5 till 20°C)

Input register		VRV	Sky-air	HRV	Split	VRV hydrobox LT & HT	Air curtains	ERQ control box	Heating	Applied																																													
On/Off	On/Off status of indoor units * For VRV hydrobox LT & HT & Heating: On/off "space cooling/heating" status and control	0	0	0	0	0*	0	0	0*	0																																													
"Forced off"	"Forced off" status of indoor unit (for each unit separate) (by T1-T2 or by central "Forced off" from the <i>Modbus Interface DIII</i>) (HRV: no "Forced off" status)	0	0	-	0	0	0	0	0	0																																													
Indoor status	Thermostat status Indoor fan status (if present) Heater status (if present)	0	0	-	0	0	0	0	0	0																																													
Fan speed (Air flow rate)	LL, L, M, H, HH (depending on indoor unit capability) * Air curtain: CYV models: not available CYQ models: available * HRV (ventilation rate): VAM models: available VKM models: not available	0	0	0*	-	-	0*	-	-	-																																													
Fan direction	Swing, Flap direction (depending on indoor unit capability)	0	0	-	-	-	-	-	-	-																																													
32001 (1-00) 32007 (1-01) ... (step of 6) 32379 (4-15)	Bit	Description	Meaning																																																				
	15	-																																																					
	14	Fan speed	0 till 7	This value is depending on "fan speed steps capability" value																																																			
	13			<table border="1"> <thead> <tr> <th>Value</th> <th>0</th> <th>1</th> <th>2</th> <th>3</th> <th>4</th> <th>5</th> <th>6</th> <th>7</th> </tr> </thead> <tbody> <tr> <td>Fix</td> <td>-</td> <td>-</td> <td>-</td> <td>-</td> <td>-</td> <td>H</td> <td>-</td> <td>-</td> </tr> <tr> <td>2step</td> <td>Auto</td> <td>L</td> <td>-</td> <td>-</td> <td>-</td> <td>H</td> <td>-</td> <td>-</td> </tr> <tr> <td>3step</td> <td>Auto</td> <td>L</td> <td>-</td> <td>M</td> <td>-</td> <td>H</td> <td>-</td> <td>-</td> </tr> <tr> <td>5step</td> <td>Auto</td> <td>LL</td> <td>L</td> <td>M</td> <td>H</td> <td>HH</td> <td>-</td> <td>-</td> </tr> </tbody> </table>							Value	0	1	2	3	4	5	6	7	Fix	-	-	-	-	-	H	-	-	2step	Auto	L	-	-	-	H	-	-	3step	Auto	L	-	M	-	H	-	-	5step	Auto	LL	L	M	H	HH	-	-
	Value			0	1	2	3	4	5	6	7																																												
	Fix	-	-	-	-	-	H	-	-																																														
	2step	Auto	L	-	-	-	H	-	-																																														
	3step	Auto	L	-	M	-	H	-	-																																														
	5step	Auto	LL	L	M	H	HH	-	-																																														
	12	HRV (ventilation rate): (note for HRV: fan speed steps capability is fixed to 0) For VAM units: value 3:L, 7:H																																																					
11	-																																																						
10	Fan direction	0 till 7	This value has only meaning if "Fan direction capability" exists																																																				
9			0: P0, 1: P1, 2:P2, 3: P3, 4: P4, 5: -, 6: Stop, 7: swing																																																				
8			P0 = horizontal direction P4 = vertical direction																																																				
7	Thermo status	0: Off 1: On																																																					
6	Heater status	0:Off 1: On																																																					
5	Fan status	0: Off 1: On																																																					
4	-																																																						

	3	Normal operation	0: Off 1: On (normal) 0: On (error)	
	2	Forced off status	0: none 1: Forced off	or Indoor status of "Forced off" of digital input T1-T2 or by central "Forced off" by <i>Modbus Interface DIII</i>
	1	-		
	0	On/off status	0: Off 1: On	

Input register		VRV	Sky-air	HRV	Split	VRV hydrobox LT & HT	Air curtains	ERQ control box	Heating	Applied
Cooling/ Heating Operation setting mode	Depending on indoor unit capability (fan only/Cool/heat/auto/dry) * for split: no fan only mode * for VRV hydrobox LT&HT & heating & applied: Only Heating&Cooling * for HRV: Only ventilation	0	0	0*	0*	0*	0	0	0*	0*
Filter sign	Filter sign of indoor units * Air curtain: CYV models: not available CYQ models: available	0	0	0	-	-	0*	-	0	-
Indoor status	Defrost/hot start status	0	0	-	0	0	0	0	0	0
	Operation status	0	0	-	-	0	0	0	0	0
32002 (1-00) 32008 (1-01) ... (step of 6) 32380 (4-15)	Bit	Description	Meaning							
	15	Cool/heat master	0 till 2	0: not decided 1: Slave 2: Master (means possible to change cool/heat operation mode via this indoor unit)						
	14									
	13	Defrost/ hot start status	0: Off 1: On							
	12	-								
	11	Operation status	0 till 2	0: Fan, 1: Heating, 2: Cooling Actual running status.						
	10									
	9									
	8									
	7	Filter sign status	0: Off 1 till 15: On							
	6									
	5									
	4									
	3	Operation mode setting	0 till 7	0: Fan, 1: Heating, 2: Cooling, 3: Auto 4: Ventilation, 5:-, 6:-, 7: Dry						
	2									
1										
0										

Input register				VRV	Sky-air	HRV	Split	VRV hydrobox LT & HT	Air curtains	ERQ control box	Heating	Applied
Room temperature set point	Set point of indoor units			0	0	-	0	0	0	0	0	-
32003 (1-00)	Bit	Description	Meaning	16 bit signed integer equals the value multiplied by 10 (bit 15= sign)								
32009 (1-01)	15..0	Set point	- 127,9 .. 127,9°C									
..(step of 6)			(unity: 0,1°C)									
32381 (4-15)												

Input register				VRV	Sky-air	HRV	Split	VRV hydrobox LT & HT	Air curtains	ERQ control box	Heating	Applied
Room temperature	Suction temperature of indoor units (or user interface sensor temperature) * Split: KRP928BB2S is required			0	0	-	0*	0	-	0	0	-
32005 (1-00)	Bit	Description	Meaning	16 bit signed integer equals the value multiplied by 10 (bit 15= sign)								
32011 (1-01)	15..0	Room temperature	- 511,9 .. 511,9°C									
.. (step of 6)												
32383 (4-15)			(unity: 0,1°C)									

Additional notes concerning the room temperature Or Suction temperature.
By default the Suction temperature value is applicable.

If the room temperature of the user interface (e.g. BRC1E52A/B7 or BRC2/3E52C7) is required, following settings should be confirmed on the user interface:

Mode No. – First Code No. () = group setting	Description of setting	Required values:
User interface settings (e.g. BRC1E52A/B7 or BRC2/3E52C7)		
1c – 1	Thermostat sensor used for the "Auto" operation mode and the Setback function (room temperature on detailed display).	Value 02: Remote controller thermistor
Unit settings		
10 (20) – 2	Thermostat sensor in the remote controller	Value 03: Use exclusively
10 (20) – 5	Sensor value information to DIII devices	Value 02: Sensor value as set by 10-2-0X or 10-6-0X.
10 (20) – 6	Thermostat sensor in group control	Value 02: Use both the unit sensor (or remote sensor if installed) AND the remote controller sensor.

For more information, refer to the installation manual of applicable indoor unit.

Input register				VRV	Sky-air	HRV	Split	VRV hydrobox LT & HT	Air curtains	ERQ control box	Heating	Applied
Leaving water set point	Leaving water set point cooling and heating * Applied: "cooling negative leaving water set point" feature: depending if function is integrated in unit.			-	-	-	-	0	-	-	0	0*
32801 (1-00) 32805 (1-01) .. (step of 4) 33053 (4-15)	Bit	Description	Meaning									
	15..0	Heating water Set point	- 127,9 .. 127,9°C (unity: 0,1°C)	16 bit signed integer equals the value multiplied by 10 (bit 15= sign)								
32802 (1-00) 32806 (1-01) .. (step of 4) 33054 (4-15)	15..0	Cooling water Set point	- 127,9 .. 127,9°C (unity: 0,1°C)	16 bit signed integer equals the value multiplied by 10 (bit 15= sign)								

Input register				VRV	Sky-air	HRV	Split	VRV hydrobox LT & HT	Air curtains	ERQ control box	Heating	Applied
Domestic hot water	Reheat enable/ disable status Storage start requested Storage set point			-	-	-	-	0	-	-	0	-
Quiet mode (low noise)				-	-	-	-	0	-	-	0	0
32803 (1-00) 32807 (1-01) .. (step of 4) 33055 (4-15)	Bit	Description	Meaning									
	15..8	Storage set point	- 128 .. 127°C (unity 1°C)	8 bit signed integer equals the value multiplied by 10 (bit 15= sign)								
	7..3	-										
	2	Low noise On/Off status	0: Off 1: On									
	1	Storage started request	0: none 1: started request									
	0	Reheat On/Off status	0: Off 1: On									

Input register				VRV	Sky-air	HRV	Split	VRV hydrobox LT & HT	Air curtains	ERQ control box	Heating	Applied
Ventilation operation mode	*VAM models: available VKM models: not available			-	-	O*	-	-	-	-	-	-
32804 (1-00) 32808 (1-01) .. (step of 4) 33056 (4-15)	Bit	Description	Meaning									
	15..8	-										
	7	Ventilation operation mode setting	1: Auto 2: Energy reclaim ventilation 3: Bypass									
	6											
5..0	-											

Input register				VRV	Sky-air	HRV	Split	VRV hydrobox LT & HT	Air curtains	ERQ control box	Heating	Applied
Error	Error, Alarm & Warning status with code and sub-code code values in ASCII code			0	0	0	0	0	0	0	0	0
33601 (1-00) 33603 (1-01) .. (step of 2) 33727 (4-15)	Bit	Description	Meaning	<p>Example: 0100 0011 0011 0111</p> <p>Error code character (higher) 01000011 (bin) = 67(dec) = ASCII "C"</p> <p>Error code character (lower) 00110111 (bin) = 55 (dec) = ASCII "7"</p> <p>Error code: "C7"</p> <p>Note: In case no error exists, then following 0011 0000 0011 0000 0011 0000 (bin) = 48(dec) = ASCII "0"</p> <p>Error code character (lower) 0011 0000 (bin) = 48 (dec) = ASCII "0"</p> <p>Error code: "00" (means no error)</p>								
	15	Error/ alarm/ warning code character (higher)	ASCII (dec)									
	14											
	13											
	12											
	11											
	10											
	9											
	8	Error/ Alarm/ warning code character (lower)	ASCII (dec)									
	7											
	6											
	5											
	4											
	3											
2												
1	33602 (1-00) 33604 (1-01) .. (step of 2) 33728 (4-15)	Error/ Alarm/ warning unit number	0.. 15	Note: only if different units are connected to the same DIII group address								
15												
14												
13												
12		-										
11		Warning status	0: Normal 1: Warning	(note: in case of Warning, the unit will not be stopped)								
10		Alarm status	0: Normal 1: Alarm	(note: in case of Alarm, the unit will not be stopped)								
9		Error status	0: Normal 1: Error	(note: in case of Error, the unit will is stopped)								
8	-											
7	Error/ Alarm/ Warning sub code	0.. 63	Note: only valid for Errors were a sub-code exists									
6												
5												
4												
3												
2												
1												
0												

3.2 Holding registers

Holding register		VRV	Sky-air	HRV	Split	VRV hydrobox LT & HT	Air curtains	ERQ control box	Heating	Applied
"Forced off"	<p>Central "Forced off" for all connected DIII units. Actual behaviour depending on user interface.</p> <p>Example: BRC1E52A/B7 & BRC2/3C52C7 centralized control icon  is shown and all connected DIII units are forced off.</p> <p>(Note: Central "forced off": Only available when no other DIII device is detected. See Input register "Other DIII device exists" 30001 bit 1)</p>	0	0	0	0	0	0	0	0	0
41001	Bit	Description	Meaning							
	15..1	-								
	0	Centralised forced off	0: none 1: Forced off	Initial value is 0.						

Additional information concerning the *forced off* function.

Situation 1: A DIII unit that lost communication to Modbus Interface DIII (due to wire communication problem or power outage of Modbus InterfaceDIII):

Consequence: After some minutes, the *forced off* will automatically be de-activated by the DIII unit.

Modbus Interface DIII required actions to return to the previous state:

In case Modbus Interface DIII also had a power outage:

After the power is restored and the DIII unit is discovered then re-activation (holding register set) of *forced off* function is required.

In case Modbus Interface DIII lost communication with DIII unit:

After re-discovery, de-activation (holding register reset) and re-activation (holding register set) of *forced off* function is required.

Situation 2: A power outage of a DIII unit only

Consequence: After the power is restored, the *forced off* is automatically activated again.

Situation 3: A power outage of a DIII unit and Modbus Interface DIII at the same time:

Consequence: After the power is restored, the *forced off* is de-activated.

Modbus Interface DIII required actions to return to the previous state:

After the power is restored and the DIII unit is discovered, re-activation (holding register set) of *forced off* function is required.

Holding register			VRV	Sky-air	HRV	Split	VRV hydrobox LT & HT	Air curtains	ERQ control box	Heating	Applied																																													
On/Off	On/Off of indoor units * For VRV hydrobox LT & HT & Heating: On/off "space cooling/heating"		0	0	0	0	0*	0	0	0*	0																																													
Fan speed (Air flow rate)	LL, L, M, H, HH (depending on indoor unit capability) * Air curtain: CYV models: not available CYQ models: available HRV (ventilation rate): VAM models: available VKM models: not available		0	0	0*	-	-	0*	-	-	-																																													
Fan direction	Swing, Flap direction (depending on indoor unit capability)		0	0	-	-	-	-	-	-	-																																													
42001 (1-00) 42004 (1-01) .. (step of 3) 42190 (4-15)	Bit	Description	Meaning																																																					
	15	-																																																						
	14	Fan speed	0 till 7	This value is depending on "fan speed steps capability" value																																																				
	13			<table border="1"> <thead> <tr> <th>Value</th> <th>0</th> <th>1</th> <th>2</th> <th>3</th> <th>4</th> <th>5</th> <th>6</th> <th>7</th> </tr> </thead> <tbody> <tr> <td>Fix</td> <td>-</td> <td>-</td> <td>-</td> <td>-</td> <td>-</td> <td>H</td> <td>-</td> <td>-</td> </tr> <tr> <td>2step</td> <td>Auto</td> <td>L</td> <td>-</td> <td>-</td> <td>-</td> <td>H</td> <td>-</td> <td>-</td> </tr> <tr> <td>3step</td> <td>Auto</td> <td>L</td> <td>-</td> <td>M</td> <td>-</td> <td>H</td> <td>-</td> <td>-</td> </tr> <tr> <td>5step</td> <td>Auto</td> <td>LL</td> <td>L</td> <td>M</td> <td>H</td> <td>HH</td> <td>-</td> <td>-</td> </tr> </tbody> </table>								Value	0	1	2	3	4	5	6	7	Fix	-	-	-	-	-	H	-	-	2step	Auto	L	-	-	-	H	-	-	3step	Auto	L	-	M	-	H	-	-	5step	Auto	LL	L	M	H	HH	-	-
	Value			0	1	2	3	4	5	6	7																																													
	Fix	-	-	-	-	-	H	-	-																																															
2step	Auto	L	-	-	-	H	-	-																																																
3step	Auto	L	-	M	-	H	-	-																																																
5step	Auto	LL	L	M	H	HH	-	-																																																
12	(note: Fan control flag bit 7-6-5-4 must be set to value 6) Note: The BMS needs to copy input register value: 32001 (1-00)... bit 14-13-12 to this holding register. (note: in case no fan capability this register should be set to 0) HRV (ventilation rate) : For VAM units: Values 0/1/2:L & 3/4/5/6/7:H (note for HRV: fan speed steps capability is fixed to 0) (note for HRV: Fan control flag bits 7-6-5-4 are not applicable) (note for HRV: Related input register with actual value: 32001 (1-00)... bit 14-13-12 Attention during the BMS copy: value 3 "L" of input register should be translated to value 2 "L" in holding register by the BMS to avoid a change to "H" ventilation rate. Value 7 "H" of input register can be copied to equal value 7 "H" in holding register.)																																																							
11	-																																																							
10	Fan direction	0 till 7	This value has only meaning if "Fan direction capability" exist																																																					
9			0: P0, 1: P1, 2: P2, 3: P3, 4: P4, 5: -, 6: Stop, 7: swing																																																					
8			P0 = horizontal direction P4 = vertical direction (note: Fan control flag must be set to value 6)																																																					

				Note: The BMS needs to copy input register value: 32001 (1-00)... bit 10-9-8) to this holding register
	7	Fan control flag	0: no fan control 6: fan control	In case fan control: This register has to be set to value 6 In case no fan control: this register has to be set to value 0 For HRV: "fan control flag" has no impact on ventilation rate control bit 14-13-12
	6			
	5			
	4			
	3	-		
	2	-		
	1	-		
	0	On/off	0: Off 1: On	Note: The BMS needs to copy input register value: value: 32001 (1-00)... bit 0) to this holding register

Holding register		VRV	Sky-air	HRV	Split	VRV hydrobox LT & HT	Air curtains	ERQ control box	Heating	Applied
Cooling/ Heating Operation mode	Depending on indoor unit capability (fan only/Cool/heat/auto/dry) * for split: no fan only mode * for VRV hydrobox LT&HT & heating & applied: Only Heating&Cooling	0	0	-	0*	0*	0	0	0*	0*
Filter sign	Filter sign reset of indoor units * Air curtain: CYV models: not available CYQ models: available	0	0	0	-	-	0*	-	0	-
42002 (1-00) 42005 (1-01) .. (step of 3) 42191 (4-15)	Bit	Description	Meaning							
	15..8	-								
	7	Filter sign reset	0: none 15: reset	Attention: After reset, set to value 0 again. Otherwise filter sign will never appear again.						
	6									
	5									
	4									
	3	Operation mode setting	0 till 7	0: Fan, 1: Heating, 2: Cooling, 3: Auto 4:Ventilation,5:-,6:Setpoint/Dependent ,7: Dry (note 6: Set point/Dependent is used when the indoor unit is not cool/heat master) Note: "illegal data" is returned in case not possible to set the value on the unit. (see chapter 2.2.1 Function format) (e.g. Set holding register to "1:heating" value to a unit that cannot be put to heating) (possible to check register 31001 for fan / cooling / heating / auto / dry mode capability) Note: The BMS needs to copy input register value: 32002 (1-00)... bit 3-2-1-0 to this holding register						
	2									
1										
0										

Holding register				VRV	Sky-air	HRV	Split	VRV hydrobox LT & HT	Air curtains	ERQ control box	Heating	Applied
Room temperature set point	Set point of indoor units			0	0	-	0	0	0	0	0	-
42003 (1-00) 42006 (1-01) .. (step of 3) 42192 (4-15)	Bit	Description	Meaning	16 bit signed integer equals the value multiplied by 10 (bit 15= sign) Remark: 1. In case the requested value is out of the unit set point range and/or the user interface set point range, the set point is set to the minimum limit value or higher limit value. 2. For the result please check for the value in the input register. Note: The BMS needs to copy input register value: 32003 (1-00)... bit 15..0) to this holding register								
	15..0	Set point	- 127,9 .. 127,9°C (unity: 0,1°C)									

Holding register				VRV	Sky-air	HRV	Split	VRV hydrobox LT & HT	Air curtains	ERQ control box	Heating	Applied
Leaving water set point	Leaving water set point cooling and heating * Applied: for cooling negative leaving water set point: depending if function is integrated in unit software.			-	-	-	-	0	-	-	0	0*
42401 (1-00) 42405 (1-01) .. (step of 4) 42653 (4-15)	Bit	Description	Meaning	16 bit signed integer equals the value multiplied by 10 (bit 15= sign) Remark: 1. In case the requested value is out of the unit set point range and/or the user interface set point range, the set point is set to the minimum limit value or higher limit value. 2. For the result please check for the value in the input register. Note: The BMS needs to copy input register value: 32801 (1-00)... bit 15..0 to this holding register.								
	15..0	Heating water Set point	- 127,9 .. 127,9°C (unity: 0,1°C)									
42402 (1-00) 42406 (1-01) .. (step of 4) 42654 (4-15)	15..0	Cooling water Set point	- 127,9 .. 127,9°C (unity: 0,1°C)	16 bit signed integer equals the value multiplied by 10 (bit 15= sign) Remark: 1. In case the requested value is out of the unit set point range and/or the user interface set point range, the set point is set to the minimum limit value or higher limit value. 2. For the result please check for the value in the input register. Note: The BMS needs to copy input register value: 32802 (1-00)... bit 15..0 to this holding register								

Holding register				VRV	Sky-air	HRV	Split	VRV hydrobox LT & HT	Air curtains	ERQ control box	Heating	Applied
Domestic hot water	Reheat enable/ disable status Storage set point			-	-	-	-	0	-	-	0	-
Quiet mode (low noise)				-	-	-	-	0	-	-	0	0
42403 (1-00) 42407 (1-01) .. (step of 4) 42655 (4-15)	Bit	Description	Meaning	8 bit signed integer equals the value multiplied by 10 (bit 15= sign) Remark: 1. In case the requested value is out of the unit set point range and/or the user interface set point range, the set point is set to the minimum limit value or higher limit value. 2. For the result please check for the value in the input register. Note: The BMS needs to copy input register value: 32803 (1-00)... bit 15..8 to this holding register.								
15	Storage set point	- 128 .. 127°C (unity 1°C)										
14												
13												
12												
11												
10												
9												
8												
7..4	-											
3	-											
2	Quiet mode (Low noise) On/Off	0: Off 1: On	Note: The BMS needs to copy input register value: 32803 (1-00)... bit 2 to this holding register.									
1	-											
0	Reheat On/off	0: Off 1: On	Note: The BMS needs to copy input register value: 32803 (1-00)... bit 0 to this holding register.									

Holding register				VRV	Sky-air	HRV	Split	VRV hydrobox LT & HT	Air curtains	ERQ control box	Heating	Applied
Ventilation operation mode	*VAM models: available VKM models: not available			-	-	0*	-	-	-	-	-	-
42404 (1-00) 42408 (1-01) .. (step of 4) 42656 (4-15)	Bit	Description	Meaning	(remark: not possible to detect if unit has capability or not) Note: The BMS needs to copy input register value: 32804 (1-00)... bit 7-6 to this holding register.								
15..8	-											
7	Ventilation operation mode setting	(0:No meaning) 1: Auto 2: Energy reclaim ventilation 3: Bypass										
6												
5..0												

Holding register		VRV	Sky-air	HRV	Split	VRV hydrobox LT & HT	Air curtains	ERQ control box	Heating	Applied
user interface lock (button) (Note: Only available when no other DIII device is detected See Input register "Other DIII device exists" 30001 bit 1)	<ul style="list-style-type: none"> - On/off lock (no lock, On lock, Off lock) - Operation mode change lock - Up-down temperature lock - Fan speed lock (if fan present) - Fan direction lock (if fan present) Actual behaviour depending on user interface. Example: BRC1E52A/B7 & BRC2/3C52C7 centralized control icon  is shown and locked function cannot be done. * Split (with KRP928BB2S) <ul style="list-style-type: none"> - On/Off lock (no lock, on/off lock) - Operation mode change & set point locked together. Function: Locked functions are ignored. * HRV: <ul style="list-style-type: none"> - On/off lock (no lock, On lock, Off lock) 	0	0	0*	0*	0	0	0	0	0
42801 (1-00) 42802 (1-01) .. (step of 1) 42864 (4-15)	Bit	Description	Meaning							
	15..7	-								
	6	-	Fixed to 0							
	5	User interface button fan speed (up/down) Lock	0: Enabled 1: Disable	Note: for * Split (with KRP928BB2S), No meaning						
	4	User interface button fan direction (up/down) Lock	0: Enabled 1: Disable	Note: for * Split (with KRP928BB2S), No meaning						
	3	User interface button operation mode Lock	0: Enabled 1: Disable	Note: for * Split (with KRP928BB2S), Operation mode change button lock & set point (up/down) button lock						
	2	User interface button set point (up/down) Lock	0: Enabled 1: Disable	Note: for * Split (with KRP928BB2S), No meaning						
	1	User interface button Off Lock	0: Enabled 1: Disable	Note: for * Split (with KRP928BB2S), No meaning						

	0	User interface button On Lock	0: Enabled 1: Disable	Note: for * Split (with KRP928BB2S), User interface On/off lock
--	---	-------------------------------	--------------------------	---

(Note: There is no related input register with actual value)

Additional information concerning the lock function.

Situation 1: A DIII unit that lost communication to Modbus Interface DIII (due to wire communication problem or power outage of Modbus InterfaceDIII):

Consequence: After some minutes, the lock will automatically be de-activated by the DIII unit.

Modbus Interface DIII required actions to return to the previous state:

In case Modbus Interface DIII also had a power outage:

After the power is restored and the DIII unit is discovered then re-activation (holding register set) of lock functions is required.

In case Modbus Interface DIII lost communication with DIII unit:

After re-discovery, de-activation (holding register reset) and re-activation (holding register set) of lock functions is required.

Situation 2: A power outage of a DIII unit only

Consequence: After the power is restored, the lock is automatically activated again.

Modbus Interface DIII required actions: none

Situation 3: A power outage of a DIII unit and Modbus Interface DIII at the same time:

Consequence: After the power is restored, the lock is de-activated.

Modbus Interface DIII required actions to return to the previous state:

After the power is restored and the DIII unit is discovered, re-activation (holding register set) of lock functions is required.

4. Software of Modbus Interface DIII

4.1 Software releases

Always verify whether you are using the latest software release. A list of the currently available software releases can be found on the Business Portal. For more information about the software itself, see below.

4.2 Software update with Updater

The *Modbus Interface DIII* software can be updated with the *Daikin Updater* PC software.

- At least *updater* v1.4.x is required. For availability, please contact your local service contact for the latest version.
- Products shipped at launch start-up will require a software update to be able to function.

Two possible connections to connect the PC to the *Modbus Interface DIII*:

Method 1) With the *PC USB cable* EKPCAB* connected to the X2A of the main board.

Method 2) With a *USB/RS485 converter* (Daikin spare - part reference 999417P) connected one on one to the RS485 Modbus port (& dipswitch DS1 off/off/off/off setting & DS2 is **not** off/off/off/off e.g. DS2 is off/off/off/on)

4.2.1 Updater

The updater PC program can be executed without admin rights.

(Remark: only during the one time USB driver installation, admin rights are required)

4.2.1.1 Updater Minimum PC requirements:

Updater (v1.4.x and higher):

- Windows XP (SP3), Windows Vista (SP2) or Windows 7 or Windows 8/8.1
- Microsoft .NET FrameWork 4.0 (aka .NET 4.0)
- Microsoft Office 2010 OR "Microsoft Access Database Engine 2010 Redistributable"
(<http://www.microsoft.com/en-us/download/details.aspx?id=13255>)
- Pentium III 400 MHz or faster
- Free USB 2.0 port, capable of supplying 50 mA current

4.2.1.1 EKPCAB* driver

In case *PC USB cable* EKPCAB* is used for the first time on a PC, it is required to install the following USB driver with admin rights.

The needed USB driver can be downloaded from "<http://www.ftdichip.com/Drivers/VCP.htm>"
E.g. download "setup executable" "2.10.00 WHQL Certified.exe" and run with admin rights.

Follow the instructions to install.

4.2.2 Method 1) Update with the PC USB cable EKPCAB*.

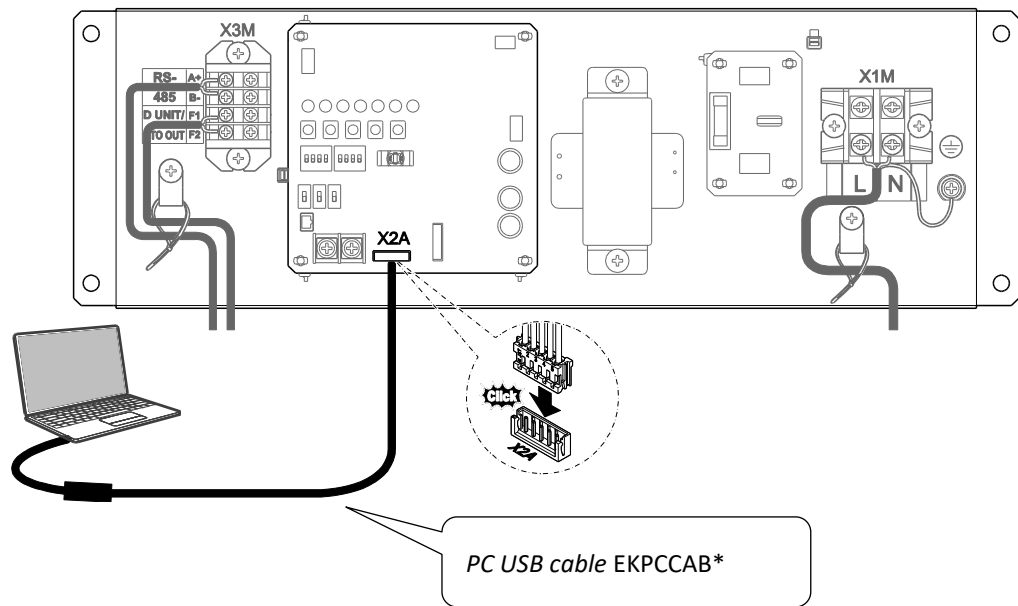

Instructions:

1. Make sure that the Modbus Interface DIII is powered off.
2. Connect the EKPCAB* cable to X2A on the mainboard (see figure).
3. Power on the Modbus Interface DIII.
4. Start the updater on the PC.

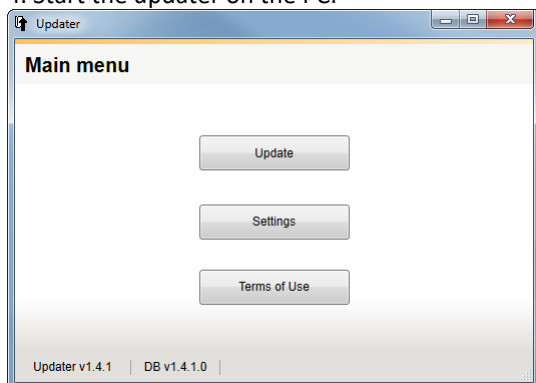

5. Proceed to the Setting menu and make sure the correct USB serial COM port is selected (e.g. COM4).

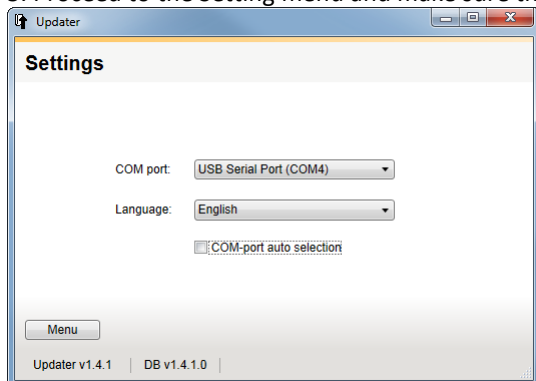

6. Proceed to the "Update Procedure Selection" window. The ID of the existing software is automatically detected.

7. Fill in the model name "EKMBDXB7V1" in the filter box and select the available software.

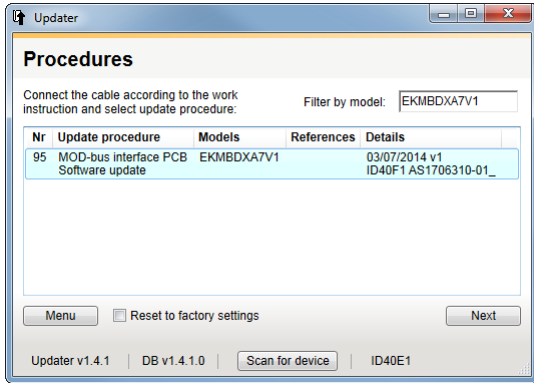

8. Follow the on-screen instructions.

Example of a successful update:

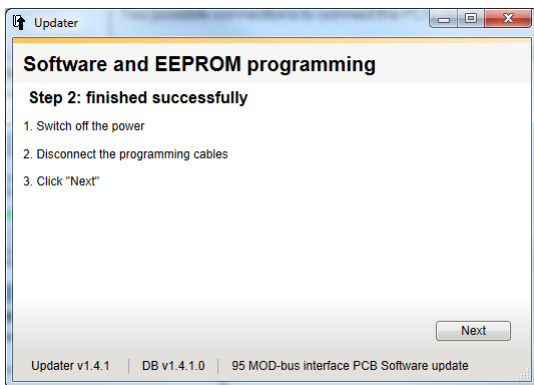
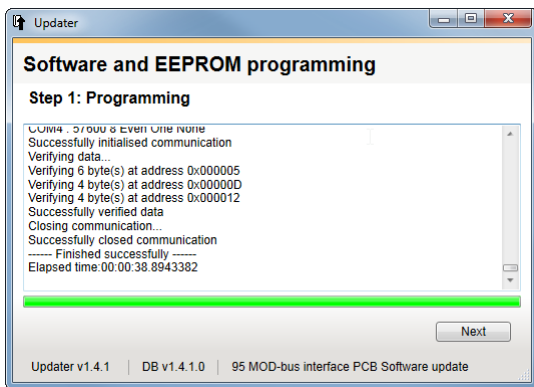

9. At the end switch off power and disconnect all programming cables.

4.2.3 Method 2) Update with a USB/RS485 converter.

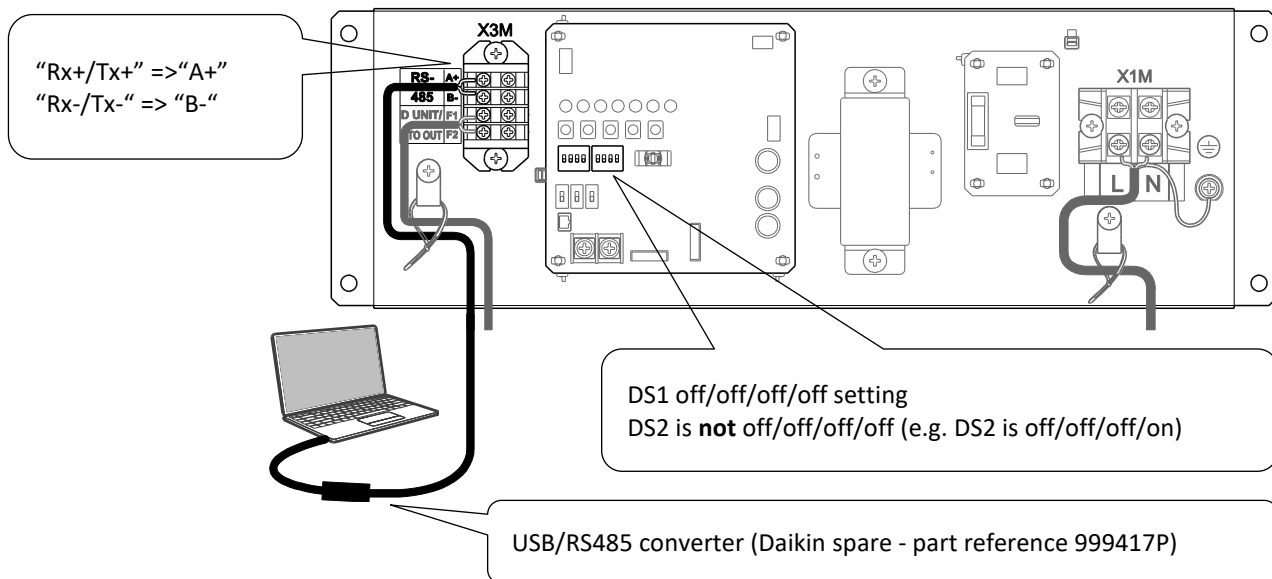

Instructions:

1. Make sure that the Modbus Interface DIII is powered off.
2. Disconnect all existing Modbus RS485 A+/B- connections and connect the USB/RS485 converter to X3M (see figure).
3. Set dipswitch DS1 & DS2 as indicated in the figure.
4. Power on the Modbus Interface DIII.
5. Start the updater on the PC.

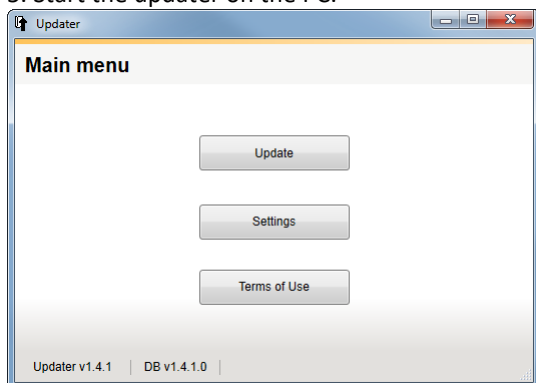

6. Proceed to the Setting menu and make sure the correct USB serial COM port is selected (e.g. COM4).

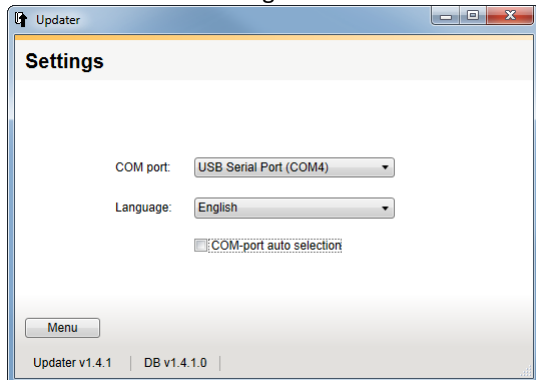

7. Proceed to the "Update Procedure Selection" window. The ID of the existing software is automatically detected.

8. Fill in the model name "EKMBDXB7V1" in the filter box and select the latest available software.

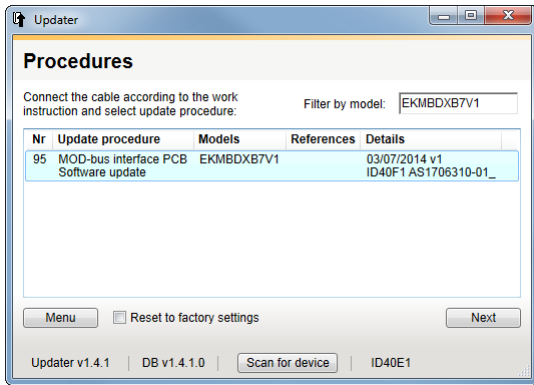

9. Follow the on-screen instructions.

Example of a successful update:

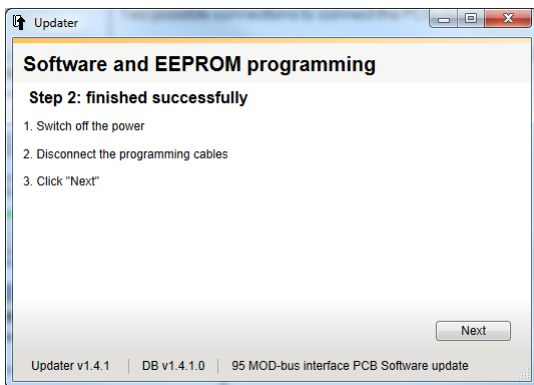
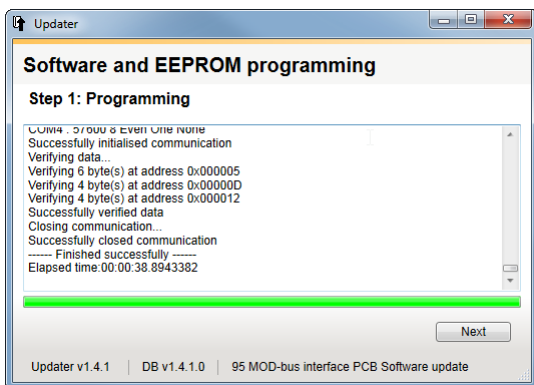

10. At the end, switch off power and disconnect all programming cables.

11. Re-set the dipperswitches to the required values.

5. Modbus Interface DIII test operation

5.1 Introduction

To test the operation of the Modbus Interface DIII setup connected to the units, a Modbus master program on a PC can be used.

An example is "Modbus Poll" PC program.

Internet download location: http://www.modbustools.com/modbus_poll.asp (shareware with a time limited trial period.)

5.2 Outline of system

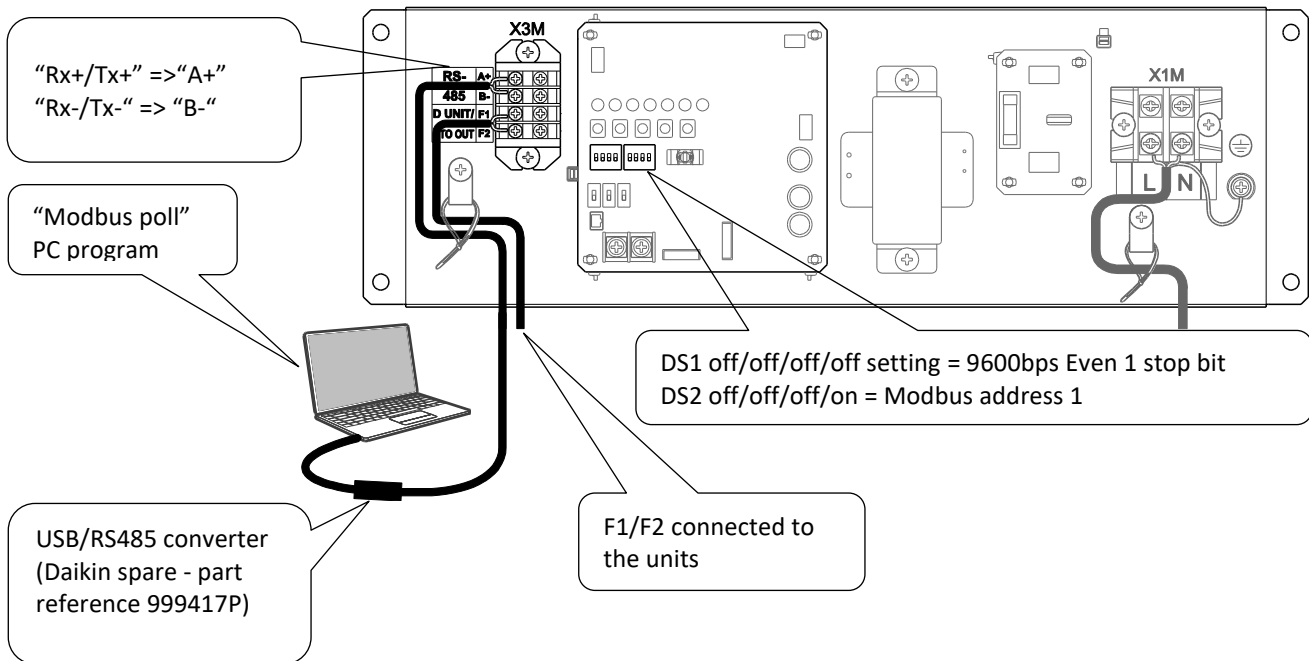

5.3 Test Operation Procedure

Following test examples are explained by using “Modbus poll” version 6.0.2

5.3.1 Prepare register groups

1. Start-up “Modbus poll”

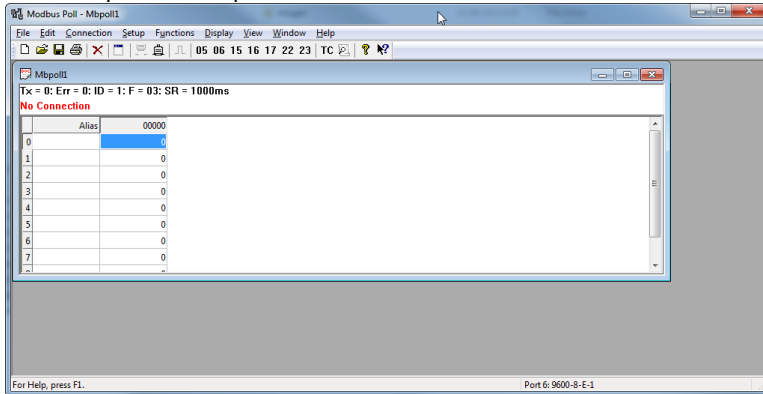

2. Setup the input registers or holding register groups by selecting following in the dropdown menu:

“File” > “New Ctrl+N”

& “Setup” > “Read/Write Definition... F8”

Note: Each registers group can be separately saved by “File” > “Save as ... “ (*.mbp)

Example how to define the input registers 30001 till 30008

Note: In “Modbus poll” the register address is defined as follows: 30011 -> 10

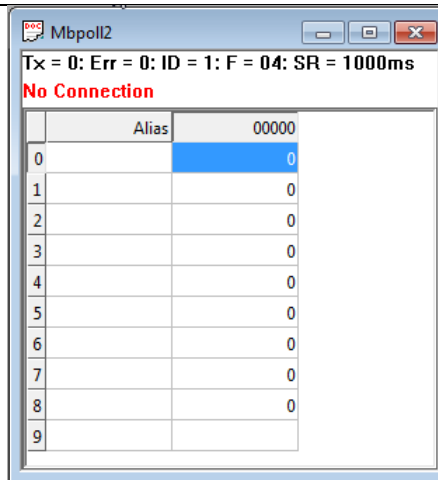
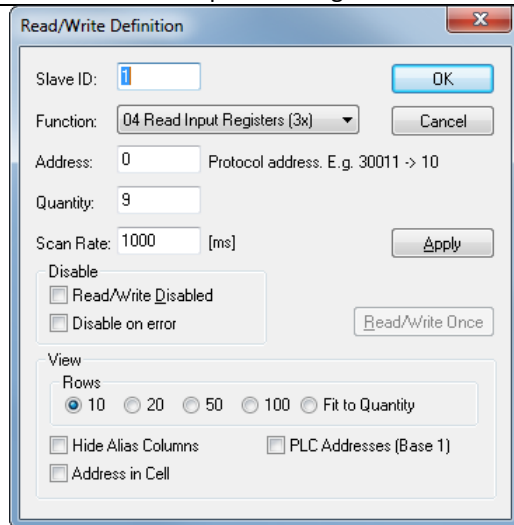

For each register the “Alias” description can be set
For each register the “Format” should be set by right clicking: “Format > binary”

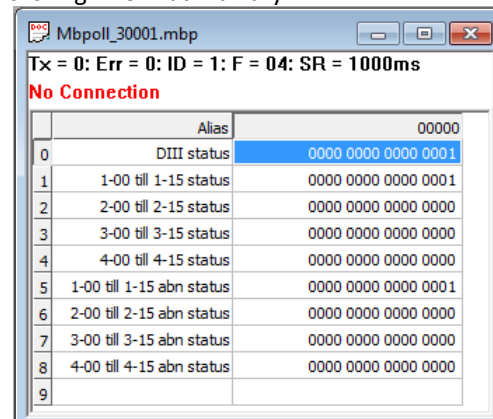

3. Prepare register groups as following examples:

Example Read input registers 30001 till 30008

Read/Write Definition

Slave ID: OK

Function: Cancel

Address: Protocol address. E.g. 30011 -> 10

Quantity:

Scan Rate: [ms] Apply

Disable

Read/Write Disabled

Disable on error Read/Write Once

View

Rows

10 20 50 100 Fit to Quantity

Hide Alias Columns PLC Addresses (Base 1)

Address in Cell

Mbpoll_30001.mbp

Tx = 0: Err = 0: ID = 1: F = 04: SR = 1000ms

No Connection

	Alias	00000
0	DIII status	0000 0000 0000 0001
1	1-00 till 1-15 status	0000 0000 0000 0001
2	2-00 till 2-15 status	0000 0000 0000 0000
3	3-00 till 3-15 status	0000 0000 0000 0000
4	4-00 till 4-15 status	0000 0000 0000 0000
5	1-00 till 1-15 abn status	0000 0000 0000 0001
6	2-00 till 2-15 abn status	0000 0000 0000 0000
7	3-00 till 3-15 abn status	0000 0000 0000 0000
8	4-00 till 4-15 abn status	0000 0000 0000 0000
9		

Example Read input registers 31001 till 31003

Read/Write Definition

Slave ID: OK

Function: Cancel

Address: Protocol address. E.g. 30011 -> 10

Quantity:

Scan Rate: [ms] Apply

Disable

Read/Write Disabled

Disable on error Read/Write Once

View

Rows

10 20 50 100 Fit to Quantity

Hide Alias Columns PLC Addresses (Base 1)

Address in Cell

Mbpoll_31001_1-00.mbp

Tx = 0: Err = 0: ID = 1: F = 04: SR = 1000ms

No Connection

	Alias	01000
1000	ind available	0000 0000 0000 0000
1001	cool sp min/max	0000 0000 0000 0000
1002	heat sp min/max	0000 0000 0000 0000

Example Read input registers 32001 till 32003

Read/Write Definition

Slave ID: OK

Function: Cancel

Address: Protocol address. E.g. 30011 -> 10

Quantity:

Scan Rate: [ms] Apply

Disable

Read/Write Disabled

Disable on error Read/Write Once

View

Rows

10 20 50 100 Fit to Quantity

Hide Alias Columns PLC Addresses (Base 1)

Address in Cell

Mbpoll_32001_1-00.mbp

Tx = 0: Err = 0: ID = 1: F = 04: SR = 1000ms

No Connection

	Alias	02000
2000	status (on/off ...)	0000 0000 0000 0000
2001	status (operation mode ...)	0000 0000 0000 0000
2002	Setpoint	0

(for set point select "Format > Signed")

Example Read holding registers 42001 till 42003

Read/Write Definition

Slave ID: OK

Function: 03 Read Holding Registers (4x) Cancel

Address: Protocol address. E.g. 40011 -> 10

Quantity: Apply

Scan Rate: [ms]

Disable

Read/Write Disabled

Disable on error Read/Write Once

View

Rows

10 20 50 100 Fit to Quantity

Hide Alias Columns PLC Addresses (Base 1)

Address in Cell

Mbpoll_42001_1-00.mbp

Tx = 0: Err = 0: ID = 1: F = 03: SR = 1000ms

No Connection

	Alias	02000
2000	fan + on/off cmd	0000 0000 0000 0000
2001	mode + filter cmd	0000 0000 0000 0000
2002	setting temperature	0

(for set point select "Format > Signed")

5.3.2 Start reading registers groups

Select "Connection > Connect F3"
(Example)

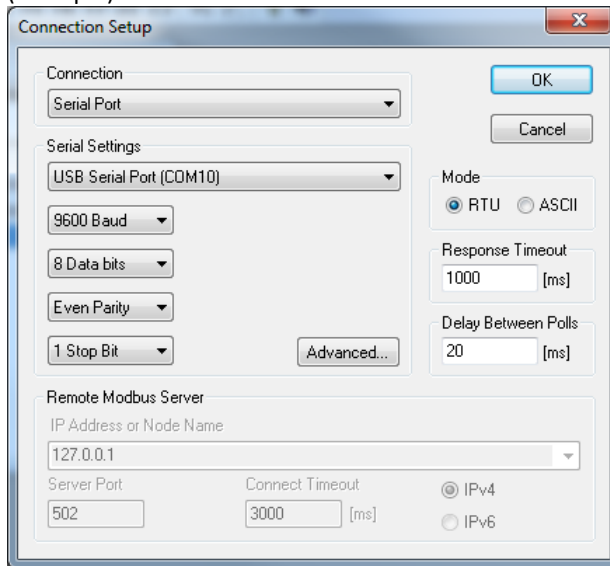

After making the correct selections, click OK to start reading the register groups.

Example Read input registers 30001 till 30008

Mbpoll_30001.mbp
Tx = 5: Err = 0: ID = 1: F = 04: SR = 1000ms

	Alias	00000
0	DIII status	0000 0000 0000 0011
1	1-00 till 1-15 status	0000 0000 0000 0001
2	2-00 till 2-15 status	0000 0000 0000 0001
3	3-00 till 3-15 status	0000 0000 0000 0001
4	4-00 till 4-15 status	0000 0000 0000 0000
5	1-00 till 1-15 abn status	0000 0000 0000 0000
6	2-00 till 2-15 abn status	0000 0000 0000 0000
7	3-00 till 3-15 abn status	0000 0000 0000 0000
8	4-00 till 4-15 abn status	0000 0000 0000 0000
9		

Example Read input registers 31001 till 31003

Mbpoll_31001_1-00.mbp
Tx = 11: Err = 0: ID = 1: F = 04: SR = 1000ms

	Alias	01000
1000	ind available	1010 1101 0001 1111
1001	cool sp min/max	0001 0000 0010 0000
1002	heat sp min/max	0001 0000 0010 0000

Example Read input registers 32001 till 32003

Mbpoll_32001_1-00.mbp
Tx = 8: Err = 0: ID = 1: F = 04: SR = 1000ms

	Alias	02000
2000	status (on/off ...)	0101 0000 0010 1001
2001	status (operation mode ...)	1000 0001 0000 0001
2002	Setpoint	170

Example Read holding registers 42001 till 42003

Mbpoll_42001_1-00.mbp
Tx = 5: Err = 0: ID = 1: F = 03: SR = 1000ms

	Alias	02000
2000	fan + on/off cmd	0000 0000 0000 0000
2001	mode + filter cmd	0000 0001 0000 0001
2002	setting temperature	170

5.3.3 Set a holding register

To change a holding register, proceed as follows:

Mbpoll_42001_1-00.mbp
Tx = 5: Err = 0: ID = 1: F = 03: SR = 1000ms

	Alias	02000
2000	fan + on/off cmd	0000 0000 0000 0000
2001	mode + filter cmd	0000 0001 0000 0001
2002	setting temperature	170

Double click on value to modify bits as follows:
(e.g. change to On)

Write Single Register Binary

Slave ID: 1

Address: 2000

Value

Result
 Response ok
 Close dialog on "Response ok"

Use Function
 06: Write single register
 16: Write multiple registers

Mbpoll_42001_1-00.mbp
Tx = 245: Err = 0: ID = 1: F = 03: SR = 1000ms

	Alias	02000
2000	fan + on/off cmd	0000 0000 0000 0000
2001	mode + filter cmd	0000 0001 0000 0001
2002	setting temperature	170

Double click on value to modify bits as follows:
(e.g. change set point to 20.0 °C)

Write Single Register

Slave ID: 1

Address: 2002

Value: 200

Result
 N/A
 Close dialog on "Response ok"

Use Function
 06: Write single register
 16: Write multiple registers

6. Troubleshooting

Problem	Possible causes	Required actions
No Modbus communication	No correct Modbus address setting was present at power on of the <i>Modbus Interface DIII</i> .	During power off: Set DS2 according to the required Modbus address. See chapter "1.3.6 Dipswitch meaning". The dipswitch on/off status is detected only at the time of power on of the PCB.
	No Modbus address setting is set (=DS2: Off/Off/Off/Off).	Set DS2 according to the required Modbus address. See chapter "1.3.6 Dipswitch meaning".
	Only firmware is present on the <i>Modbus Interface DIII</i> . HAP: is blinking at a fast rate of 200ms meaning firmware is running.	Upload the latest application software. See chapter "4.2 Software update with Updater".
Software update with updater (via RS485) fails	DS2 is set to off/off/off/off. (meaning no communication on RS485).	Change DS2 settings to e.g. off/off/off/on. Refer to chapter "4.2.3 Method 2) Update with a USB/RS485 converter."
A BMS set of a holding register is not reflected on the actual unit.	<i>Modbus Interface DIII</i> sends the command to a unit when the value of a Holding Register is changed. Especially in case that indoor units are operated from the user interface.	The BMS should always get the status of indoor units and copy the received status to the Holding Registers. Refer to chapter "2.3.2 Monitor and operate units from the BMS".

7. Revision of the document

2014.04	New
2020.10	Adaptation for EKMBDXB7V1

