

DAIKIN



OPERATION MANUAL

Condenserless water-cooled water chillers



EWLP012KBW1N
EWLP020KBW1N
EWLP026KBW1N
EWLP030KBW1N
EWLP040KBW1N
EWLP055KBW1N
EWLP065KBW1N

CONTENTS

	Page
Introduction	1
Technical specifications	2
Electrical specifications	2
Description	3
Function of the main components.....	4
Safety devices.....	4
Internal wiring - Parts table.....	5
Before operation.....	6
Checks before initial start-up	6
Water supply	6
Power supply connection and crankcase heating.....	6
General recommendations	6
Operation	6
Digital controller.....	6
Working with the units.....	7
Advanced features of the digital controller.....	10
BMS connection modbus	13
General description of Modbus.....	13
Implemented error code.....	14
Defining the BMS setting	14
Variables database	14
Troubleshooting.....	15
Maintenance.....	16
Important information regarding the refrigerant used	16
Maintenance activities	16
Disposal requirements	16
Annex I	17
Saturated temperature.....	17
Menu overview	18

INTRODUCTION

This operation manual concerns condensorless water-cooled water chillers of the Daikin EWLP-KB series. These units are provided for indoor installation and used for cooling applications. The EWLP units can be combined with Daikin fan coil units or air handling units for air conditioning purposes. They can also be used for supplying water for process cooling.

This manual has been prepared to ensure adequate operation and maintenance of the unit. It will tell you how to use the unit properly and will provide help if problems occur. The unit is equipped with safety devices, but they will not necessarily prevent all problems caused by improper operation or inadequate maintenance.

In case of persisting problems contact your local Daikin dealer.



Before starting up the unit for the first time, make sure that it has been properly installed. It is therefore necessary to carefully read the installation manual supplied with the unit and the recommendations listed in "Before starting".



READ THIS MANUAL ATTENTIVELY BEFORE STARTING UP THE UNIT. DO NOT THROW THIS MANUAL AWAY. KEEP IT IN YOUR FILES FOR FUTURE REFERENCE.
 Read the chapter "Operation" on page 6 before changing the parameters.

The English text is the original instruction. Other languages are translations of the original instructions.

This appliance is not intended for use by persons, including children, with reduced physical, sensory or mental capabilities, or lack of experience and knowledge, unless they have been given supervision or instruction concerning use of the appliance by a person responsible for their safety.

Children should be supervised to ensure that they do not play with the appliance.

Technical specifications⁽¹⁾

General EWLP		012	020	026	030
Dimensions HxWxD	(mm)		600x600x600		
Machine weight	(kg)	104	138	144	149
Connections					
• condenser discharge connection (copper)	(mm)	12.7 flare	19.1 flare	19.1 flare	19.1 flare
• condenser liquid connection (copper)	(mm)	9.52 flare	12.7 flare	12.7 flare	12.7 flare

General EWLP		040	055	065
Dimensions HxWxD	(mm)		600x600x1200	
Machine weight	(kg)	252	265	274
Connections				
• condenser discharge connection (copper)	(mm)	2x 19.1 flare	2x 19.1 flare	2x 19.1 flare
• condenser liquid connection (copper)	(mm)	2x 12.7 flare	2x 12.7 flare	2x 12.7 flare

Compressor EWLP		012	020	026	030
Model		JT140BF-YE	JT212DA-YE	JT300DA-YE	JT335DA-YE
Speed	(rpm)	2900			
Oil type		FVC68D			
Oil charge volume	(l)	1.5	2.7	2.7	2.7
Refrigerant type		R407C			
Evaporator					
Type		brased plate heat exchanger			
Min. water volume	(l)	62.1	103	134	155
Water flow range	(l/min)	31~69	53~115	65~153	76~179
Condenser					
refer to engineering specifications as published by the supplier of your remote condenser					
Compressor EWLP		040	055	065	
Model		2x JT212DA-YE	2x JT300DA-YE	2x JT335DA-YE	
Speed	(rpm)	2900			
Oil type		FVC68D			
Oil charge volume	(l)	2x 2.7	2x 2.7	2x 2.7	
Refrigerant type		R407C			
Evaporator					
Type		brased plate heat exchanger			
Min. water volume	(l)	205	268	311	
Water flow range	(l/min)	101~229	131~307	152~359	
Condenser					
refer to engineering specifications as published by the supplier of your remote condenser					

Electrical specifications⁽²⁾

Model EWLP		012	020	026	030
Power supply					
• Phase		3N~			
• Frequency	(Hz)	50			
• Voltage	(V)	400			
• Voltage tolerance	(%)	±10			
• Recommended fuses	(aM)	3x 16	3x 20	3x 25	3x 32
Compressor					
• Phase		3~			
• Frequency	(Hz)	50			
• Voltage	(V)	400			
• Nominal running current	(A)	7.4	11.6	14.7	16.8
Control					
• Phase		1~			
• Frequency	(Hz)	50			
• Voltage	(V)	230			
• Recommended fuses	(aM)	factory installed			

Model EWLP		040	055	065
Power supply				
• Phase		3N~		
• Frequency	(Hz)	50		
• Voltage	(V)	400		
• Voltage tolerance	(%)	±10		
• Recommended fuses	(aM)	3x 40	3x 50	3x 50
Compressor				
• Phase		3~		
• Frequency	(Hz)	50		
• Voltage	(V)	400		
• Nominal running current	(A)	11.6	14.7	16.8
Control				
• Phase		1~		
• Frequency	(Hz)	50		
• Voltage	(V)	230		
• Recommended fuses	(aM)	factory installed		

(1) Refer to the engineering data book for the complete list of specifications.

(2) Refer to the engineering data book for the complete list of specifications.

DESCRIPTION

The EWLP condensersless water-cooled water chillers are available in 7 standard sizes.

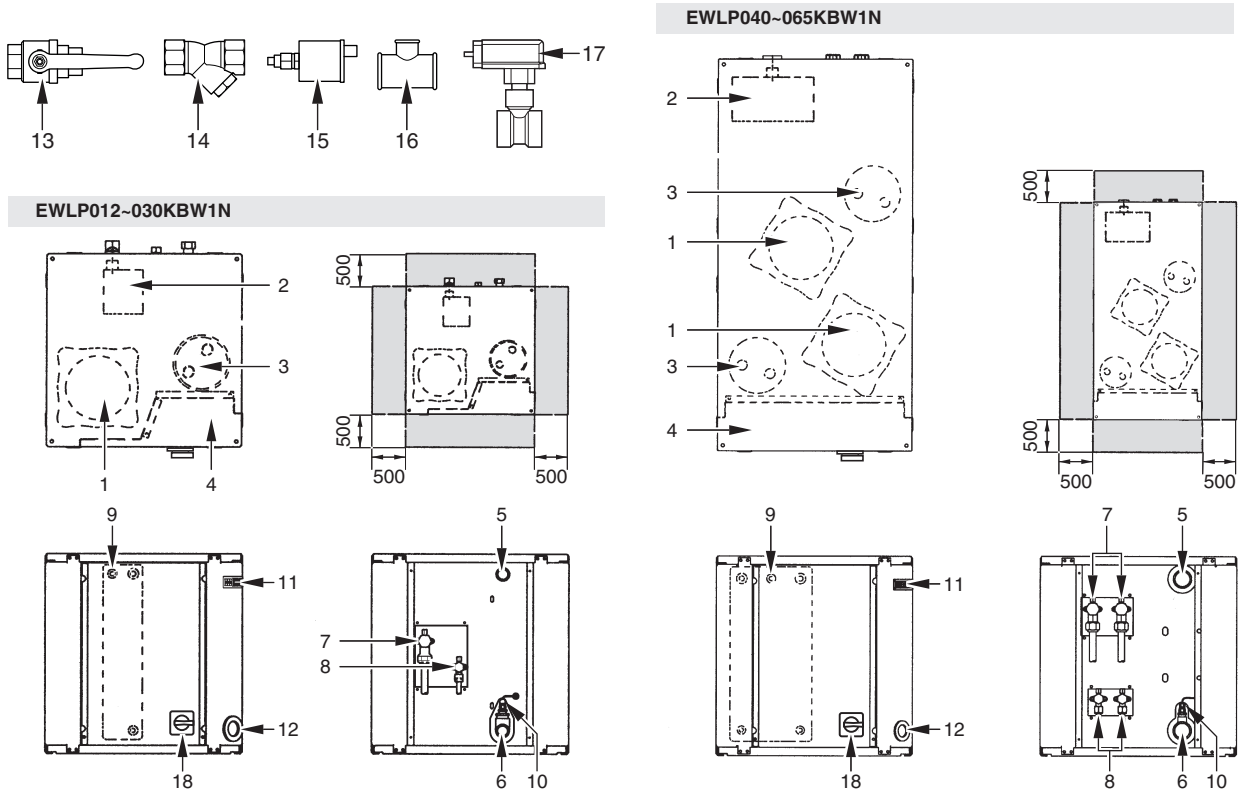

Figure: Main components

- 1 Compressor
- 2 Evaporator
- 3 Accumulator
- 4 Switchbox
- 5 Chilled water in
- 6 Chilled water out
- 7 Discharge stop valve
- 8 Liquid stop valve
- 9 Evaporator entering water temperature sensor
- 10 Freeze up sensor
- 11 Digital display controller
- 12 Power supply intake
- 13 Ball valve (field installed)
- 14 Water filter (field installed)
- 15 Air purge valve (field installed)
- 16 T-joint for air purge (field installed)
- 17 Flow switch (with T-joint) (field installed)
- 18 Main switch

Required space around the unit for service

Function of the main components

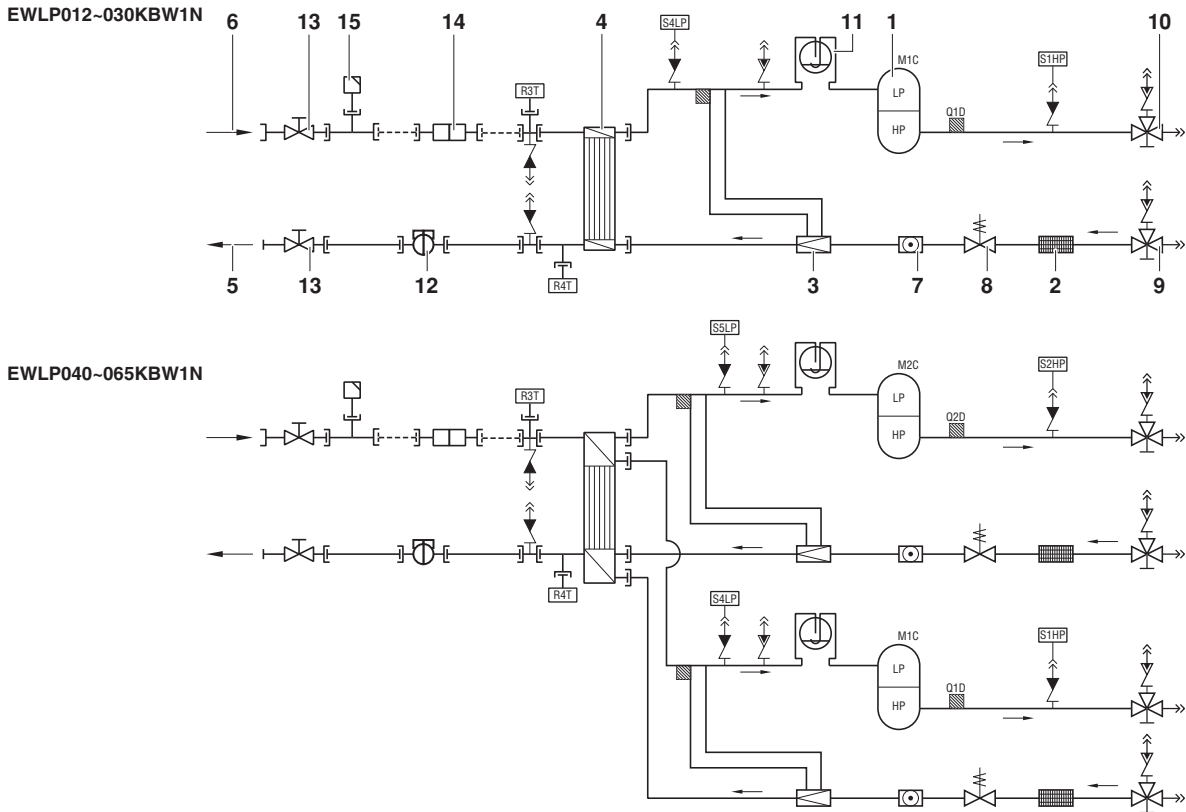

Figure: Functional diagram

- | | | | |
|---|-------------------------|-----|---|
| 1 | Compressor | 9 | Liquid stop valve |
| 2 | Filter | 10 | Discharge stop valve |
| 3 | Expansion valve | 11 | Accumulator |
| 4 | Evaporator | 12 | Flow switch (delivered with the unit, installed in the field) |
| 5 | Evaporator water outlet | 13 | Ball valve (delivered with the unit, installed in the field) |
| 6 | Evaporator water inlet | 14 | Water filter (delivered with the unit, installed in the field) |
| 7 | Sight glass | 15 | Air purge valve (delivered with the unit, installed in the field) |
| 8 | Liquid solenoid valve | --- | Field piping |

As the refrigerant circulates through the unit, changes in its state or condition occur. These changes are caused by the following main components:

- **Compressor**

The compressor (M^{*C}) acts as a pump and circulates the refrigerant in the refrigeration circuit. It compresses the refrigerant vapour coming from the evaporator to a pressure at which it can easily be liquified in the condenser.
- **Filter**

The filter installed behind the condenser removes small particles from the refrigerant to prevent blockage of the tubes.
- **Expansion valve**

The liquid refrigerant coming from the condenser enters the evaporator via an expansion valve. The expansion valve brings the liquid refrigerant to a pressure at which it can easily be evaporated in the evaporator.
- **Evaporator**

The main function of the evaporator is to take heat from the water that flows through it. This is done by turning the liquid refrigerant, coming from the condenser, into gaseous refrigerant.
- **Water in/outlet connections**

The water inlet and outlet connection allow an easy connection of the unit to the water circuit of the air handling unit or industrial equipment.

Safety devices

The unit is equipped with *General safety devices*: shut down all circuits and stop the whole unit.

- **I/O PCB (A2P) (input/output)**

The I/O PCB (A2P) contains a reverse phase protector.

The reverse phase protector detects if the 3 phases of the power supply are connected correctly. If a phase is not connected or if 2 phases are inverted, the unit can not start up.
- **Overcurrent relay**

The overcurrent relay (K^{*S}) is located in the switch box of the unit and protects the compressor motor in case of overload, phase failure or too low voltage. The relay is factory-set and may not be adjusted. When activated, the overcurrent relay has to be reset in the switch box and the controller needs to be reset manually.
- **High-pressure switch**

The high-pressure switch (S^{*HP}) is installed on the discharge pipe of the unit and measures the condenser pressure (pressure at the outlet of the compressor). When the pressure is too high, the pressure switch is activated and the circuit stops.

When activated, it resets automatically, but the controller needs to be reset manually.

■ Low pressure switch

The low-pressure switch (S*LP) is installed on the suction pipe of the unit and measures the evaporator pressure (pressure at the inlet of the compressor). When the pressure is too low, the pressure switch is activated and the circuit stops.

When activated, it resets automatically, but the controller needs to be reset manually.

■ Discharge thermal protector

The discharge thermal protector (Q*D) is activated when the temperature of the refrigerant leaving the compressor becomes too high. When the temperature returns to normal, the protector resets automatically, but the controller needs to be reset manually.

■ Freeze up sensor

The outlet water temperature sensor (R4T) measures the temperature of the water at the water heat exchanger outlet. The protection device shuts down the circuit when the temperature of the chilled water becomes too low in order to prevent freezing of the water during operation.

When the outlet water temperature returns to normal, the protector resets automatically, but the controller needs to be reset manually.

■ Fuse for control circuit (F1U)

The fuse for control circuit protects cables of control circuit and controller components in case of short circuit.

■ Fuse for control circuit (F4)

The fuse for control circuit protects cables of control circuit in case of short circuit.

■ Fuse for digital controller (F3U)

The fuse protects cables of digital controller and digital controller in case of short circuit.

■ Flow switch (delivered with the unit, installed in the field)

The flow switch measures the flow in the water circuit. In case the flow does not reach the minimum allowed water flow, the unit will be shut down.

■ Ball valve (delivered with the unit, installed in the field)

A ball valve is installed in front of and behind the water filter to allow filter cleaning without having to drain the water circuit.

■ Water filter (delivered with the unit, installed in the field)

The filter installed in front of the unit removes dirt from the water to prevent damage to the unit or blockage of the evaporator or condenser. The water filter should be cleaned on a regular base.

■ Air purge valve (delivered with the unit, installed in the field)

Remaining air in the chiller water system will be automatically removed via the air purge valve.

Internal wiring - Parts table

Refer to the internal wiring diagram supplied with the unit. The abbreviations used are listed below:

- A1P.....PCB: controller PCB
- A2P.....PCB: I/O PCB (input/output)
- A3P..... **PCB: Address card for BMS⁽¹⁾
- A5P,A6P **PCB: Softstarter for circuit 1, circuit 2⁽¹⁾
- A7P..... **PCB: Remote user interface⁽¹⁾
- A71P.....PCB: power supply card
- A72P.....PCB: remote user interface
- E1H,E2HCrankcase heater circuit 1, circuit 2
- F1,F2,F3..... #.....Main fuses for the unit⁽²⁾
- F4 *.....Fuse I/O PCB
- F5 ## ...Surge proof fuse
- F6 #Fuse for pumpcontactor⁽²⁾
- F1U.....Fuse I/O PCB
- F3U.....Fuse for controller PCB
- H3P *.....Indication lamp alarm⁽²⁾
- H4P *.....Indication lamp operation compressor 1⁽²⁾
- H5P *.....Indication lamp operation compressor 2⁽²⁾
- H6P *.....Indication lamp general operation⁽²⁾
- K1F,K2F..... #.....Auxiliary contactor for fan motors
- K1M,K2M.....Compressor contactor circuit 1, circuit 2
- K4S,K5S.....Overcurrent relay circuit 1, circuit 2
- K6S..... *.....Overcurrent relay pump⁽²⁾
- K1P..... *.....Pumpcontactor
- M1C,M2CCompressor motor circuit 1, circuit 2
- PE.....Main earth terminal
- Q1D,Q2DDischarge thermal protector circuit 1, circuit 2
- R3T.....Evaporator inlet water temperature sensor
- R4T.....Evaporator outlet water temperature sensor
- R5T.....Condenser inlet temperature sensor
- S1HP,S2HPHigh pressure switch circuit 1, circuit 2
- S4LP,S5LPLow pressure switch circuit 1, circuit 2
- S7S..... *.....Switch for remote cooling/heating selection⁽²⁾ or dual setpoint
- S9S..... *.....Switch for remote start/stop⁽²⁾ or dual setpoint
- S10L.....Flow switch
- S12M.....Main isolator switch
- TR1.....Transfo 230 V → 24 V for supply of controller PCB
- TR2.....Transfo 230 V → 24 V for supply of I/O PCB (A2P)
- Y3RReversingvalve
- Y1S, Y2SLiquid solenoid valve
- X1~3,X1~82A.....Connectors

	Not included with standard unit	
	Not possible as option	Possible as option
Obligatory	#	##
Not obligatory	*	**

(1) optional
(2) field supply

BEFORE OPERATION

Checks before initial start-up



Make sure that the circuit breaker on the power supply panel of the unit is switched off.

After the installation of the unit, check the following before switching on the circuit breaker:

1 Field wiring

Make sure that the field wiring between the local supply panel and the unit has been carried out according to the instructions described in the installation manual, according to the wiring diagrams and according to European and national regulations.

2 Fuses or protection devices

Check that the fuses or the locally installed protection devices are of the size and type specified in the installation manual. Make sure that neither a fuse nor a protection device has been bypassed.

3 Earth wiring

Make sure that the earth wires have been connected properly and that the earth terminals are tightened.

4 Internal wiring

Visually check the switch box on loose connections or damaged electrical components.

5 Fixation

Check that the unit is properly fixed, to avoid abnormal noises and vibrations when starting up the unit.

6 Damaged equipment

Check the inside of the unit on damaged components or squeezed pipes.

7 Refrigerant leak

Check the inside of the unit on refrigerant leakage. If there is a refrigerant leak, call your local dealer.

8 Oil leak

Check the compressor on oil leakage. If there is an oil leak, call your local dealer.

9 Power supply voltage

Check the power supply voltage on the local supply panel. The voltage should correspond to the voltage on the identification label of the unit.

Water supply

Fill the water piping, taking into account the minimum water volume required by the unit. Refer to the chapter "Water charge, flow and quality" in the installation manual.

Make sure that the water is of the quality as mentioned in the installation manual.

Purge the air at the high points of the system and check the operation of the circulation pump and the flow switch.



- Use a good thread sealant for the sealing of the connections. The sealing must be able to withstand the pressures and temperatures of the system, it must also be resistant to the used glycol in the water.
- The exterior of the water pipes must be adequately protected against corrosion.

Power supply connection and crankcase heating



In order to avoid compressor damage, it is necessary to switch on the crankcase heater for **at least six hours** before starting the compressor after a long period of standstill.

To switch on the crankcase heater proceed as follows:

- 1 Switch on the circuit breaker on the unit. Make sure that the unit is "OFF" on the controller.
- 2 The crankcase heater is switched on automatically.
- 3 Check the supply voltage on the supply terminals L1, L2, L3, (N) by means of a voltmeter. The voltage should correspond to the voltage indicated on the identification label of the unit. If the voltmeter reads values which are not within the ranges specified in the technical data, check the field wiring and replace the supply cables if necessary.
- 4 Check the LED on the reverse phase protector. If it lights up, the phase order is correct. If not, switch off the circuit breaker and call a licensed electrician to connect the wires of the power supply cable in the correct phase order.

After six hours, the unit is ready for operation.

General recommendations

Before switching on the unit, read following recommendations:

- 1 When the complete installation and all necessary settings have been carried out, close all front panels of the unit.
- 2 The service panel of the switch box may only be opened by a licensed electrician for maintenance purposes.

OPERATION

The EWLP units are equipped with a digital controller offering a user-friendly way to set up, use and maintain the unit.

This part of the manual has a task-oriented, modular structure. Apart from the first section, which gives a brief description of the controller itself, each section or subsection deals with a specific task you can perform with the unit.

Digital controller

User interface

The digital controller consists of a numeric display, four labelled keys which you can press and LEDs providing extra user information.



Figure - Digital controller

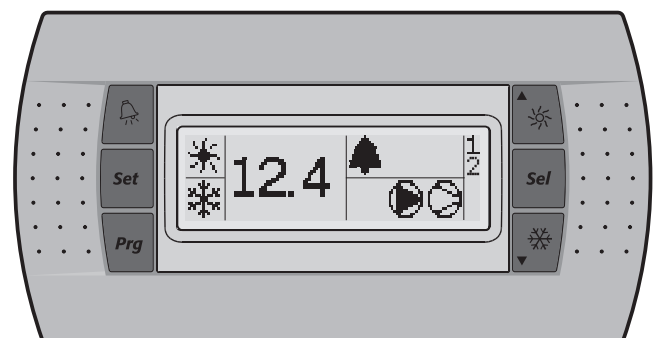

Figure - Remote user interface (optional kit)

Keys provided on the controller:

The function carried out when the user presses one or a combination of these keys depends on the status of the controller and the unit at that specific moment.

Keys digital controller	Keys remote interface	Main display	Sensor readout menu	Parameter selection menu	Parameter setting menu
	■	—	Press once: Return	Press once: Return	Press once: Cancel and return
	■	Press for 5 seconds: To be able to access DIRECT parameters	—	Press once: Select parameter group or parameter	Press once: Confirm and return
+	■	Press for 5 seconds: + OR Press once: ■ To be able to access USER parameters (after entering USER password)	—	—	—
		Press for 5 seconds: Switch unit on/off in heating mode Press once: Direct access to readout menu sensor (b0 1/b02/b03)	Press once: Select previous sensor parameter	Press once: Select previous parameter group or parameter	Press once: Increase value
		Press for 5 seconds: Switch unit on/off in cooling mode Press once: Direct access to readout menu sensor (b0 1/b02/b03)	Press once: Select next sensor parameter	Press once: Select next parameter group or parameter	Press once: Decrease value
+	■	Press for 5 seconds: Manually alarm reset in the event of alarm	—	—	—

LEDs provided on the controller and remote interface:

Function during main display (not inside menu)

Leds digital controller	Remote interface	Main display
■	Led (green)	Inlet water temperature.
✱	Led (amber)	Indicates that heating mode is active.
❄	Led (amber)	Indicates that cooling mode is active.
🔔	Led (red)	Indicates that the alarm is active.
🔵	Led (amber)	Indicates the status of the pump
⊖	Led (amber)	LED, indicates that at least one compressor is active.
1	Led (amber)	1 LED is on, indicates that compressor 1 is active. LED is flashing, indicates compressor 1 startup request.
2	Led (amber)	2 LED is on, indicates that compressor 2 is active. LED is flashing, indicates compressor 2 startup request.

When selecting a parameter group or parameter, different LEDs related to the parameter group or parameter are displayed.

Example: The LEDs ✱ and ❄ are displayed when accessing a parameter group or when accessing parameters directly.

NOTE Temperature readout tolerance: ±1°C.
 Legibility of the numeric display may decrease in direct sunlight.

Direct and user parameters

The digital controller provides direct and user parameters. The direct parameters are important for the everyday usage of the unit, e.g. to adjust the temperature setpoint or to consult actual operational information. The user parameters on the contrary provide advanced features such as adjusting time delays.

Each parameter is defined by a code and a value. For example: the parameter used to select local or remote on/off control has code H07 and value 1 or 0.

For an overview of the parameters, refer to "Overview of the direct and user parameters" on page 10.



Working with the units

This chapter deals with the everyday usage of the EWLP units. Here, you will learn how to perform routine tasks, such as:



- "Switching the unit on" on page 8 and "Switching the unit off" on page 8,
- "Adjusting the cooling temperature setpoint" on page 8,
- "Consulting actual operational information" on page 9,
- "Resetting alarms" on page 9,
- "Resetting warnings" on page 9.



Switching the unit on

To switch the unit on in cooling mode, proceed as follows:

- 1 Press the  key for approximately 5 seconds, the  LED will be displayed.

To switch the unit on in heating mode, proceed as follows:

- 1 Press the  key for approximately 5 seconds, the  LED will be displayed.

In both cases an initialization cycle is started, the  LED, the  LED, the 1 LED and the 2 LED will light up depending on the programmed thermostat function.

In case the 1 LED or the 2 LED is flashing, it indicates that there is a compressor 1 or 2 startup request. The compressor will start after the timer has reached zero.

NOTE  If remote on/off control is enabled, refer to "Selecting local or remote on/off control" on page 12.

- 2 When the unit is started up for the first time, or when the unit has been out of operation for a longer period, it is recommended to go through the following checklist.

Abnormal noise and vibrations

Make sure the unit does not produce any abnormal noises or vibrations: check the fixations and piping. If the compressor makes any abnormal noises, this may also be caused by an overcharge of refrigerant.

Working pressure

It is important to check the high and low pressure of the refrigerant circuit to ensure the proper operation of the unit and to guarantee that the rated output will be obtained.

For reference, the average saturated temperature of R407C in relation to the pressure readout can be found in "Annex I" on page 17.



The pressures measured will vary between a maximum and minimum value, depending on the water and outdoor temperatures (at the moment of measurement).



- 3 If the unit does not start after a few minutes, consult the actual operational information available in the list of direct parameters. Also refer to the chapter "Troubleshooting" on page 15.

NOTE  In case of remote on/off control ($HO7=1$), it is recommended to install an on/off switch near the unit in series with the remote switch. The unit can then be switched off from either place.



The selection of cooling mode or heating mode can only be carried out at startup. Selecting an opposite mode without switching the unit off is impossible.

Switching the unit off

To switch the unit off and cooling mode is active, proceed as follows:

- 1 Press the  key for approximately 5 seconds, the  LED will be extinguished.













To switch the unit off and heating mode is active, proceed as follows:

- 1 Press the  key for approximately 5 seconds, the  LED will be extinguished.

NOTE  If remote on/off control is enabled, refer to "Selecting local or remote on/off control" on page 12.

How to consult and modify the direct parameters

For an overview of the menu structure, refer to "Menu overview" on page 18.





- 1 Press  for 5 seconds in the main display. The r parameter group is displayed.
- 2 Press the  or  key to select the required parameter group.
- 3 Press the  key to enter the selected parameter group.
- 4 Press the  or  key to select the required parameter.
- 5 Press the  key to consult the selected parameter.
- 6 Press the  or  key to raise, respectively lower the setting of the selected parameter. (Only valid for read/write parameters.)
- 7 Press the  key to confirm the modified setting.
OR
Press the  key to cancel the modified setting.
- 8 Press the  key to return to the parameter group.
- 9 Press 2 times the  key to return to the main display.

If during the procedure no buttons are pressed for 30 seconds, the displayed parameter code or value will start flashing. After another 30 seconds without pressing any buttons, the controller automatically returns to the main display without saving any modified parameter.

How to consult the "sensor readout menu" parameters

For an overview of the menu structure, refer to "Menu overview" on page 18.

The $b01/b02/b03$ parameters are part of the "sensor readout menu".

- 1 Press the  or  key in the main display. The $b01$ parameter is displayed. In case no buttons are pressed, the value of the $b01$ sensor will be displayed until  or  is pressed again to select another parameter ($b02$ or $b03$).
- 2 Press the  key to return to the main display.

If during the procedure no buttons are pressed for 30 seconds, the displayed parameter code or value will start flashing. After another 30 seconds without pressing any buttons, the controller automatically returns to the main display.

Adjusting the cooling temperature setpoint

- 1 Modify the r cooling setpoint parameter.

This is a direct parameter, refer to "How to consult and modify the direct parameters" on page 8.

NOTE  When dual setpoint is enabled (refer to "Selecting dual setpoint control" on page 12).

Consulting actual operational information

The actual operational information that can be consulted in the list of direct parameters consists of:

- $b01$: Evaporator inlet water temperature,
- $b02$: Evaporator outlet water temperature,
- $b03$: When cooling mode is active: inlet water temperature of the condenser. When heating mode is active: inlet water temperature of the evaporator.
- $c10$: Total running hours of the compressor 1,
- $c11$: Total running hours of the compressor 2,
- $c15$: Total running hours of the pump.

NOTE



- The parameters $b01$, $b02$ and $b03$ can also be consulted by the "sensor readout menu". Refer to "How to consult the "sensor readout menu" parameters" on page 8.
- To reset the timers of parameters $c10$, $c11$ and $c15$ refer to "Resetting warnings" on page 9.

These are direct parameters, refer to "How to consult and modify the direct parameters" on page 8.

Resetting alarms

When an alarm is detected, the following happens:

- the alarm relay is energized,
- the \uparrow LED is displayed
- the display starts flashing, alternately showing the alarm code and the inlet water temperature.

The following alarm codes may appear on the screen:

- $R1$: indicates an anti-freeze alarm.
- $E1$: indicates that the NTC probe used to measure the evaporator inlet water temperature is defective.
- $E2$: indicates that the NTC probe used to measure the evaporator outlet water temperature is defective.
- $E3$: indicates that the fuse for the evaporator heatertape (F4) is blown or that there is a reverse phase error or that there is a problem with the I/O PCB (A2P).



In case the unit is equipped with freeze protection, it is highly recommended to install the remote indicator lamp alarm (H3P) (see wiring diagram supplied with the unit). By doing so, breakdown of the fuse for the evaporator heatertape (F4) will be detected sooner and freezing of the circuit will be avoided during cold weather.

- EHS : indicates that the supply voltage is exceedingly high. In this case contact a licensed electrician.
- $EL1$: indicates that there is a power supply error (example: noise). In this case contact a licensed electrician.
- $EL2$: indicates that there is a power supply error (example: noise). In this case contact a licensed electrician.
- ELS : indicates that the supply voltage is exceedingly low. In this case contact a licensed electrician.
- EPb : indicates that the EEPROM on the controller PCB inside the unit is defective.
- EPr : indicates that the EEPROM on the controller PCB inside the unit is defective.
- FL : indicates that there was no sufficient water flow either during the period of 15 seconds after the pump was started or for 5 seconds while the compressor is active or that the overcurrent protection of the pump is activated.
- $HP1$: indicates that a high pressure switch, the discharge thermal protection or the overcurrent protection of the compressor motor is activated or that the NTC probe used to measure the ambient temperature is defective.

- $FL + HP1$: indicates that there is most likely an RPP error or that the F4 fuse is blown.
- $LP1$: indicates that the low pressure switch is activated.
- LER : indicates that there is a remote user interface communication error.
- **Offline**: communication failure between the digital controller of the unit and the remote user interface. Confirm the correct selection of parameter code $H23$. This should be default setting 0 and confirm the correction installation according to the installation manual of the remote user interface EKRMCA.

NOTE



If the alarm codes FL and $HP1$ are flashing alternately, the alarm is most probably caused by the reverse phase protector or by the fuse for evaporator heatertape (F4) that was blown.

To reset an alarm, proceed as follows:

- 1 Find the cause of shutdown and correct.
Refer to the chapter "Troubleshooting" on page 15.
- 2 If the alarm codes $R1$, FL , $HP1$ or $LP1$ appear on the display, reset the alarm manually by pressing the *clear* combination keys \blacktriangle and \blacktriangledown simultaneously for approximately 5 seconds.
In all other cases the alarm is reset automatically.
Once the alarm is reset, the error code and the \uparrow LED no longer appears on the display. The controller continues its normal operation, displaying the inlet water temperature.

Resetting warnings

During normal operation, the display of the controller may start flashing, alternately showing the inlet water temperature and the following warning code:

- $Hc1$: indicates that the compressor 1 requires maintenance: the total running hours of the compressor 1 (direct parameter $c10$) has exceeded the setting of the timer threshold for maintenance warning (user parameter $c14$).
- $Hc2$: indicates that the compressor 2 requires maintenance: the total running hours of the compressor 2 (direct parameter $c11$) has exceeded the setting of the timer threshold for maintenance warning (user parameter $c14$).

To reset the maintenance warning $Hc1$ or $Hc2$, proceed as follows:

- 1 Consult $c10$ running hours of compressor 1 or $c11$ running hours of compressor 2.
These are direct parameters, refer to "How to consult and modify the direct parameters" on page 8.
- 2 When $c10$ or $c11$ parameter value is displayed, press the \blacktriangle and \blacktriangledown key simultaneously for 5 seconds. The value of the timer becomes 0 and the warning is reset.

NOTE



Do not forget to carry out the required maintenance activities after resetting the timers.

Besides resetting timer $c10$ and $c11$, it is also possible to reset timer $c15$ (running hours of pump) in the same way.

Advanced features of the digital controller

This chapter gives an overview of the direct parameters and user parameters provided by the controller. In the following chapter, you will learn how you can set up and configure the unit using these parameters.

Overview of the direct and user parameters

The list of direct parameters is accessible by pressing the  key for approximately 5 seconds. Refer also to "How to consult and modify the direct parameters" on page 8.

Parameter group	Parameter code	Description	Default value	Min	Max	Units	Read/Write	User/Direct	Modbus Address	Parameter type ^(*)
-r-	r23	Measurement unit $\bar{0}$ =°C $\bar{1}$ =°F	0	0	1		R/W	U	5	D
-R-	No user or direct parameters accessible									
-b-	b01	Evaporator inlet water temperature				0.1°C	R	D	102	A
	b02	Evaporator outlet water temperature				0.1°C	R	D	103	A
	b03	When cooling mode is active: inlet water temperature of the condenser. When heating mode is active: inlet water temperature of the evaporator.				0.1°C	R	D	104	A
-c-	c07	Time delay between pump startup and compressor startup	15	0	999	1 sec	R/W	U	238	I
	c08	Time threshold between the unit shutdown and the pump shutdown	0	0	150	1 min	R/W	U	239	I
	c10	Total running hours of compressor 1				x100 hours	R	D	122	A
	c11	Total running hours of compressor 2				x100 hours	R	D	123	A
	c14	Maintenance threshold for maintenance warning (c10 and c11)	0	0	100	x100 hours	R/W	U	241	I
c15	Total running hours of pump				x100 hours	R	D	126	A	
-d-	No user or direct parameters accessible									
-F-	No user or direct parameters accessible									
-H-	H0b	To activate remote cool/heat control $\bar{0}$ =not active $\bar{1}$ =active (only in case P09=9)	0	0	1		R/W	U	14	D
	H07	To activate remote on/off control $\bar{0}$ =not active $\bar{1}$ =active (only in case P34=23)	0	0	1		R/W	U	15	D
	H09	To lock the controller keyboard $\bar{0}$ =lock $\bar{1}$ =unlock	1	0	1		R/W	U	16	D
	H10	Serial address for BMS connection	1	1	200		R/W	U	256	I
	H23	To select address card connection $\bar{0}$ =remote user interface connection $\bar{1}$ =MODBUS connection	0	0	1		R/W	U	11	D
-P-	P09	Changeable digital input selection S7S $\bar{0}$ =no function $\bar{9}$ =remote cool/heat (only active in combination with H0b) $\bar{13}$ =remote dual setpoint DO NOT SELECT OTHER VALUES	9	0	27		R/W	U	277	I
	P34	Changeable digital input selection S9S $\bar{0}$ =no function $\bar{13}$ =remote dual setpoint $\bar{23}$ =remote on/off (only active in combination with H07) DO NOT SELECT OTHER VALUES	23	0	27		R/W	U	329	I
-r-	r01	Cooling setpoint	12.0	8.0 ^(†)	25.0	0.1°C	R/W	D	41	A
	r02	Cooling difference	3.0	0.3	19.9	0.1°C	R/W	D	42	A
	r03	Heating setpoint	30.0	15.0	50.0	0.1°C	R/W	D	43	A
	r04	Heating difference	3.0	0.3	19.9	0.1°C	R/W	D	44	A
	r21	Cooling setpoint 2 ^(‡)	12.0	8.0 ^(†)	25.0	0.1°C	R/W	D	55	A
	r22	Heating setpoint 2 ^(‡)	30.0	15.0	50.0	0.1°C	R/W	D	56	A
-t-	No user or direct parameters accessible									
F-r	H99	Software release version					R	D	208	I

(*) D=digital, A=analog, I=integer.

(†) -2.0 and -7.0 only applicable for units with glycol applications.

(‡) Used in case dual setpoint is enabled in P09 or P34 and dual setpoint digital input is closed.

How to consult and modify the user parameters

NOTE When user parameters are consulted, the direct parameters are displayed as well.

For an overview of the menu structure, refer ["Menu overview"](#) on page 18.

- 1 In case of digital controller, press the **[Prg/mem]** and **[Sel/]** keys for approximately 5 seconds until **0.0.0** is displayed.
In case of remote user interface, push **■** once.
- 2 Enter the correct password by using the **[▲/※]** and **[※/▼]** keys. The password's value is **22**.
- 3 Press the **[Sel/]** key to confirm the password and to enter the menu, **S-P** is displayed.
- 4 Press the **[Sel/]** key to consult the parameter settings (=S-P). (L-P means consulting the parameter level, but this function is not used).
The **-r-** parameter group is displayed.
- 5 Press the **[▲/※]** or **[※/▼]** key to select the required parameter group.
- 6 Press the **[Sel/]** key to enter the selected parameter group.
- 7 Press the **[▲/※]** or **[※/▼]** key to select the required parameter.
- 8 Press the **[Sel/]** key to consult the selected parameter.
- 9 Press the **[▲/※]** or **[※/▼]** key to increase, respectively decrease the setting. (Only valid for read/write parameters.)
- 10 Press the **[Sel/]** key to confirm the modified setting.
OR
Press the **[Prg/mem]** key to cancel the modified setting.
- 11 Press the **[Prg/mem]** key to return to the parameter group.
- 12 Press 2 times the **[Prg/mem]** key to return to the main display.

If during the procedure no buttons are pressed for 30 seconds, the displayed parameter code or value will start flashing. After another 30 seconds without pressing any buttons, the controller automatically returns to the main display without saving any modified parameter.

Defining the cooling temperature differential

Modify the **r02** cooling differential parameter.

This is a direct parameter, refer to ["How to consult and modify the direct parameters"](#) on page 8.

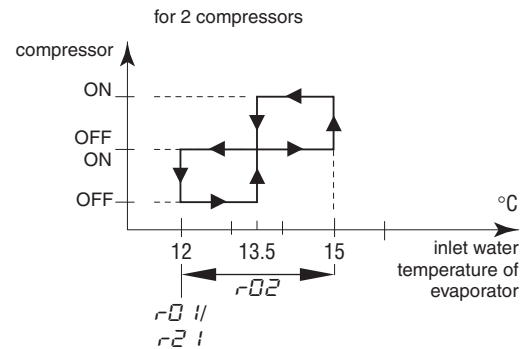
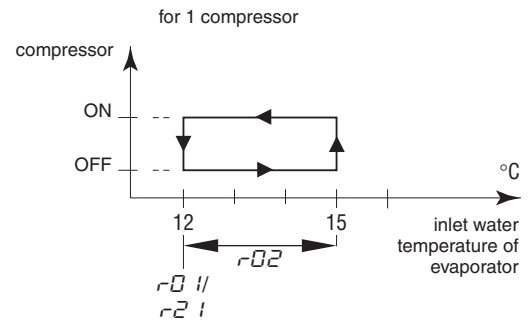

Defining the heating temperature differential

Modify the **r04** heating differential parameter.

This is a direct parameter, refer to ["How to consult and modify the direct parameters"](#) on page 8.

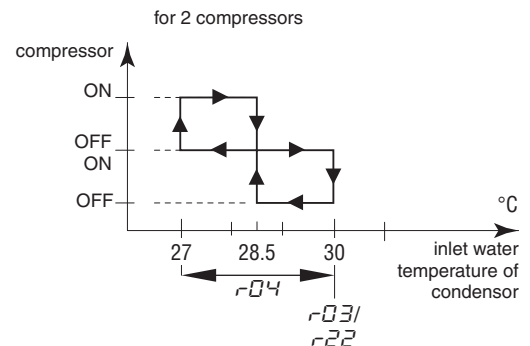
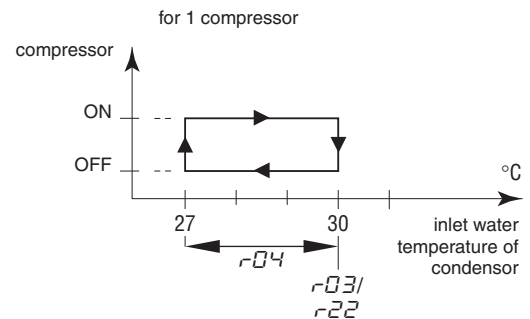

Tasks carried out using user parameters

Defining the measurement unit

Depending on the setting of user parameter $r23$ (measurement unit), all temperature values are displayed in °C (=0) or in °F (=1).

This is a user parameter, refer to "How to consult and modify the user parameters" on page 11.

Defining the time delay between pump and compressor startup

User parameter $c07$ allows you to define the time delay between the pump startup and the compressor startup.

This is a user parameter, refer to "How to consult and modify the user parameters" on page 11.

Defining the time delay between unit and pump shutdown

User parameter $c08$ allows you to define the time delay between the unit shutdown and the pump shutdown, more specifically the period during which the pump will still be active after the unit has been shut down.

This is a user parameter, refer to "How to consult and modify the user parameters" on page 11.

Defining the timer threshold for maintenance warning

User parameter $c14$ allows you to define a timer threshold (running hours of the compressor) after which the controller will generate a maintenance warning or request.

This is a user parameter, refer to "How to consult and modify the user parameters" on page 11.

Selecting local or remote cool/heat control

User parameter $H0b$ in combination with the remote cool/heat selection switch (installed by the customer) allows the user to select cooling or heating mode without using the [] or [] key on the controller.

- When user parameter $H0b$ is set to 0 (=not active), cooling or heating mode is determined by means of the controller.
- When user parameter $H0b$ is set to 1 (=active), cooling or heating mode is determined by means of the remote switch.

This is a user parameter, refer to "How to consult and modify the user parameters" on page 11.

NOTE



- This is only in case $P09$ (changeable digital input selection S7S) has value 9 (default value).
- In case dual setpoint function is selected for this function ($P09=13$) then the remote cool/heat control is not activated. Meaning the [] or [] keys on the controller are still active.

Selecting local or remote on/off control

User parameter $H07$ in combination with the remote on/off switch (installed by the customer) allows the user to switch the unit on without using the [] or [] key on the controller.

- When user parameter $H07$ is set to 0 (=not active), the unit can only be switched on by means of the [] and [] key on the controller.
- When user parameter $H07$ is set to 1 (=active), the unit can be switched on or off as follows:
 - When remote on/off switch is opened, then the unit is switched off and it is not possible to switch the unit on/off while pressing the [] or [] key on the controller (5 sec).
 - When remote on/off switch is closed, then the unit is switched on and it is possible to switch the unit on/off while pressing the [] or [] key on the controller (5 sec).

This is a user parameter, refer to "How to consult and modify the user parameters" on page 11.

NOTE



- This is only in case $P34$ (changeable digital input selection S9S) has value 23 (default value).
- In case dual setpoint function is selected for this function ($P34=13$) then the remote on/off control is not activated.

Selecting dual setpoint control

User parameters $P09$ (changeable digital selection S7S) and $P34$ (changeable digital selection S9S) can be used to assign the dual setpoint control to S7S or S9S.

There are 3 different controls available for 2 different change digital inputs (S7S and S9S):

- $P09$: changeable digital input selection S7S
 - 0=no function
 - 9=remote cool/heat
 - 13=remote dual setpoint
- $P34$: changeable digital input selection S9S
 - 0=no function
 - 13=remote dual setpoint
 - 23=remote on/off

When dual setpoint switch is open, the first setpoint is activated ($r01$ cooling setpoint or $r03$ heating setpoint, depending on cooling or heating operation).

When dual setpoint switch is closed, the second setpoint is activated ($r21$ cooling setpoint 2 or $r23$ heating setpoint 2, depending on cooling or heating operation).

This is a user parameter, refer to "How to consult and modify the user parameters" on page 11.

Locking the controller keyboard

Once user parameter $H09$ is set to 0 , the following advanced features can no longer be carried out by means of the controller:

- modifying direct and user parameters (parameters can be displayed but not modified),
- resetting the timers.
- switching the unit on/off in cooling or heating

When user parameter $H09$ is set to 1 , the above-described advanced features can be carried out using the controller.

To modify user parameter $H09$ value from 1 to 0 , the standard user parameter modification procedure can be used with the standard password "22". Refer to "How to consult and modify the user parameters" on page 11.

To modify user parameter $H09$ value from 0 to 1 , the user parameter modification procedure can be used with dedicated password "11". Refer to "How to consult and modify the user parameters" on page 11.

BMS CONNECTION MODBUS

By installing the optional kit address card EKAC10C, you will be able to communicate with your chiller through a Building Management System or supervisory system via the Modbus protocol.

General description of Modbus

The address card communicates using the Modbus protocol.

Different parts of the communication network

- The communication network consists of two major players:
 - The Building Management System (BMS) or supervisory system.
 - The chiller or multiple chillers.
- The BMS or other supervisory system is able to communicate with the chillers through the address card.

The management of the communication occurs in accordance with a master-slave structure in polling, where the supervising BMS is the master and the address cards are the slaves.
- The chiller unit can be identified by the supervisor through the assignment of an address within the Modbus network. The address of the chiller unit can be programmed during the configuration of the BMS settings.
- The variables database of every chiller with installed address card is the point of reference for the supplier of the supervisory system in Modbus to assign a suitable meaning to the variables. The variables can be read and/or written by the supervisory system. Whether the variables are read-only or read/write depends on the connected chiller and/or the application program being used.
 - If the supervisory system assigns a value to a variable with read-only status, the command will not be executed at all.
 - Variables requested by the supervisory system that are not available in a chiller with an address card are sent from the address card to the supervisory system with zero value. The supervisory system will have to manage these properly.
 - In case the supervisory system tries to write a value of a parameter that is out of range, the writing will be ignored.

General information about the Modbus protocol

The Modicon Modbus protocol implemented in the address card complies with the content of the following document:

Modicon Modbus Protocol
Reference Guide
June 1996, PI-MBUS-300 Rev. J

The Modbus protocol implemented is of the RTU (Remote Terminal Unit) type based on character transmission times. The configuration uses the multi-drop feature of RS485. The address sent within the Modbus packet addresses the chiller unit.

Implemented RS485 communication settings for the Modbus protocol

The RS485 communication settings are implemented as follows:

- Baud-rate: 9600
- Stop bit: 2
- Parity: none

Implemented commands for the Modbus protocol

The implemented commands in the program are as listed:

Modbus command	Meaning	Notes
01 read coil status	Read digital variable(s)	obtains current status (ON/OFF) of a group of logic coils or discrete input
02 read input status	Read digital variable(s)	obtains current status (ON/OFF) of a group of logic coils or discrete input
03 read holding registers	Read analogue variable(s)	obtains current binary value in one or more holding registers
04 read input registers	Read analogue variable(s)	obtains current binary value in one or more holding registers
05 force single coil	Write individual digital variable(s)	forces single coil to ON or OFF status
06 preset single register	Write individual analogue variable(s)	places a specific binary value into a holding register
15 force multiple coils	Write series of digital variables	forces a series of consecutive logic coils to be defined to ON or OFF status
16 preset multiple registers	Write series of analogue variables	places specific binary values into a series of consecutive holding registers

Note that:

- Due to the variety of chillers with installed address cards, no distinction is made between input variables (with read-only status) and output variables (with read/write status) so that the knowledge of the database and its management depends on the part present on the supervisory system.
- Due to the general nature of the system, the address card answers in the same way to various Modbus commands.

Data representation of the Modbus protocol

- Digital
All digital data is coded by a single bit:
 - "0" for OFF
 - "1" for ON.
 All digital variables are assigned to bits of consecutive registers, each one having:
 - the lower-address variable assigned to the less significant bit
 - the higher-address variable assigned to the most significant bit.
- Analogue and integer data
An analogue and integer value is represented by a 16-bit WORD register in binary notation. For each register, the first byte contains the high order bits and the second byte contains the low order bits.
 - The analogue variables are represented in tenths:
for example, the value 10.0 is transmitted as 0064h=100d
for example, the value -10.0 is transmitted as FF9Ch=-100d
 - The integer variables are transferred using the effective value:
for example, the value 100 is transmitted as 0064h=100d
 The address card operates on registers where one register must be considered at 16-bit.

In case the BMS or supervisory system tries to write a value of a parameter that is out of range, the writing will be ignored.

Implemented error code

Code	Modbus interpretation	Condition
1	Illegal function	Message is not supported or the number of variables required is greater than the allowed limit (length ≤20)

Defining the BMS setting

Activating the Modbus protocol

The Modbus protocol is activated by setting the $H23$ parameter to 1. This is a user parameter, refer to "How to consult and modify the user parameters" on page 11.

Defining the unit's serial address

To define each unit's unique serial address required for communication with the supervisory system, set parameter $H10$.

This is a user parameter, refer to "How to consult and modify the user parameters" on page 11.

Variables database

The BMS or supervisory system and the chiller unit communicate through a fixed set of variables, also called address numbers. Hereafter, you will find the information you need about the digital, integer and analogue variables that the BMS or supervisory system can read from or write to the address card of the chiller.

For addresses of all the direct and user parameters refer to "Overview of the direct and user parameters" on page 10.

Overview of all variables which are not direct or user parameters

Description		Modbus address	Parameter type(*)	
Circuit alarm	1=A1, HP1, or LP1 alarm codes active 0=no alarm code active	Read only	41	D
General alarm	1=FL alarm code 0=no alarm code active	Read only	45	D
NTC Probe alarm	1=E1, E2, or E3 alarm codes 0=no alarm code active	Read only	46	D
Input of flowswitch alarm	1=closed 0=open	Read only	53	D
Input of changeable digital S7S input	1=closed 0=open	Read only	54	D
Input of high pressure or discharge protector or overcurrent alarm	1=closed 0=open	Read only	55	D
Input of low pressure switch alarm	1=closed 0=open	Read only	56	D
Input of changeable digital S9S input	1=closed 0=open	Read only	57	D
Output of compressor 1	1=on 0=off	Read only	59	D
Output of compressor 2	1=on 0=off	Read only	60	D
Output of pump	1=on 0=off	Read only	61	D
Output of reversing valve	1=on 0=off	Read only	62	D
Output of alarm	1=on 0=off	Read only	63	D
On or off	1=on 0=off	Read/write	64	D
Cooling or heating	1=cooling 0=heating	Read/write	65	D

(*) D=digital.

TROUBLESHOOTING

This section provides useful information for diagnosing and correcting certain troubles which may occur in the unit.

Before starting the trouble shooting procedure, carry out a thorough visual inspection of the unit and look for obvious defects such as loose connections or defective wiring.

Before contacting your local dealer, read this chapter carefully, it will save you time and money.



When carrying out an inspection on the supply panel or on the switch box of the unit, always make sure that the circuit breaker of the unit is switched off.

When a safety device was activated, stop the unit and find out why the safety device was activated before resetting it. Under no circumstances safety devices may be bridged or changed to a value other than the factory setting. If the cause of the problem cannot be found, call your local dealer.

Symptom 1: The unit does not start, but the LED lights up

POSSIBLE CAUSES	CORRECTIVE ACTION
The temperature setting is not correct.	Check the controller setpoint.
Power supply failure.	Check the voltage on the supply panel.
Blown fuse or interrupted protection device.	Inspect fuses and protection devices. Replace by fuses of the same size and type (refer to chapter "Electrical specifications" on page 2).
Loose connections.	Inspect connections of the field wiring and the internal wiring of the unit. Tighten all loose connections.
Shorted or broken wires.	Test circuits using a tester and repair if necessary.

Symptom 2: The unit does not start, but the LED is flashing

POSSIBLE CAUSES	CORRECTIVE ACTION
The flowstart timer is still running.	The unit will start after approx. 15 seconds. Make sure that water is flowing through the evaporator.
The anti-recycling timer is still active.	The circuit can only start up after approximately 6 minutes.
The guard timer is still active.	The circuit can only start up after approximately 1 minute.

Symptom 3: The unit does not start and the LED does not light up

POSSIBLE CAUSES	CORRECTIVE ACTION
One of the following safety devices is activated: <ul style="list-style-type: none"> Reverse phase protector Overcurrent relay (K*S) Discharge thermal protector (Q*D) Evaporating temperature thermostat (S*T) Flow switch (S10L) High pressure switch (S*HP) 	Check on the controller and refer to symptom "4. One of the following safety devices is activated". Refer to the explanation of the digital controller in the chapter "Resetting alarms" on page 9.
The unit is in anti-freeze alarm.	Check on the controller and refer to symptom "4. One of the following safety devices is activated". Refer to the explanation of the digital controller in the chapter "Resetting alarms" on page 9
The remote ON/OFF input is enabled and the remote switch is off.	Put the remote switch on or disable the remote ON/OFF input.
The keyboard is locked. The user parameter $H09$ is set to \square .	Unlock the controller keyboard.

Symptom 4: One of the following safety devices is activated

Symptom 4.1: Overcurrent relay of compressor	
POSSIBLE CAUSES	CORRECTIVE ACTION
Failure of one of the phases.	Check fuses on the supply panel or measure the supply voltage.
Voltage too low.	Measure the supply voltage.
Overload of motor.	Reset. If the failure persists, call your local dealer.
RESET	
<i>Push the red button on the over-current relay inside the switch box. The controller still needs to be reset.</i>	
Symptom 4.2: Low pressure switch or anti-freeze alarm	
POSSIBLE CAUSES	CORRECTIVE ACTION
Water flow to water heat exchanger too low.	Increase the water flow.
Shortage of refrigerant.	Check for leaks and refill refrigerant, if necessary.
Unit is working out of its operation range.	Check the operation conditions of the unit.
Inlet temperature to the water heat exchanger is too low.	Increase the inlet water temperature.
Flow switch is not working or no water flow.	Check the flow switch and the water pump.
RESET	
<i>After pressure rise, the low pressure switch resets automatically, but the controller still needs to be reset.</i>	
Symptom 4.3: High-pressure switch	
POSSIBLE CAUSES	CORRECTIVE ACTION
Condenser fan does not operate properly.	Check that the fans turn freely. Clean if necessary.
Dirty or partially blocked condenser.	Remove any obstacle and clean condenser coil using brush and blower.
Inlet air temperature of the condenser is too high.	The air temperature measured at the inlet of the condenser should not exceed 43°C.
RESET	
<i>After pressure decrease, the high pressure switch resets automatically, but the controller still needs to be reset.</i>	
Symptom 4.4: Reverse phase protector is activated	
POSSIBLE CAUSES	CORRECTIVE ACTION
Two phases of the power supply are connected in the wrong phase position.	Invert two phases of the power supply (by licensed electrician).
One phase is not connected properly.	Check the connection of all phases.
RESET	
<i>After inverting two phases or fixing the power supply cables properly, the protector is reset automatically, but the unit still needs to be reset.</i>	
Symptom 4.5: Discharge thermal protector is activated	
POSSIBLE CAUSES	CORRECTIVE ACTION
Unit is working outside the operation range.	Check the operation condition of the unit.
RESET	
<i>After temperature decrease, the thermal protector resets automatically but the controller still needs to be reset.</i>	
Symptom 4.6: Flow switch is activated	
POSSIBLE CAUSES	CORRECTIVE ACTION
No water flow.	Check the water pump.
RESET	
<i>After finding the cause, the flow switch is reset automatically, but the controller still needs to be reset.</i>	

Symptom 5: Unit stops soon after operation

POSSIBLE CAUSES	CORRECTIVE ACTION
One of the safety devices is activated.	Check safety devices (refer to symptom "4. One of the following safety devices is activated").
Voltage is too low.	Test the voltage in the supply panel and, if necessary, in the electrical compartment of the unit (voltage drop due to supply cables is too high).

Symptom 6: Unit runs continuously and the water temperature remains higher than the temperature set on the controller

POSSIBLE CAUSES	CORRECTIVE ACTION
The temperature setting on the controller is too low.	Check and adjust the temperature setting.
The heat production in the water circuit is too high.	The cooling capacity of the unit is too low. Call your local dealer.
Water flow is too high.	Recalculate the water flow.

Symptom 7: Excessive noises and vibrations of the unit

POSSIBLE CAUSES	CORRECTIVE ACTION
Unit has not been fixed properly.	Fix the unit as described in the installation manual.

MAINTENANCE

In order to ensure optimal availability of the unit, a number of checks and inspections on the unit and the field wiring have to be carried out at regular intervals.

If the unit is used for air conditioning application, the described checks should be executed at least once a year. In case the unit is used for other applications, the checks should be executed every 4 months.



Before carrying out any maintenance or repair activity, always switch off the circuit breaker on the supply panel, remove the fuses or open the protection devices of the unit.

Do never clean the unit with water under pressure.

Important information regarding the refrigerant used

This product contains fluorinated greenhouse gases covered by the Kyoto Protocol.

Refrigerant type: R407C

GWP⁽¹⁾ value: 1652.5

⁽¹⁾ GWP = global warming potential

Periodical inspections for refrigerant leaks may be required depending on European or local legislation. Please contact your local dealer for more information.

Maintenance activities



The wiring and power supply must be checked by a licensed electrician.

■ Field wiring and power supply

- Check the power supply voltage on the local supply panel. The voltage should correspond to the voltage marked on the identification label of the unit.
- Check the connections and make sure they are properly fixed.
- Check the proper operation of the circuit breaker and the earth leak detector provided on the local supply panel.

■ Internal wiring of the unit

Visually check the switch box on loose connections (terminals and components). Make sure that the electrical components are not damaged or loose.

■ Earth connection

Make sure that the earth wires are still connected properly and that the earth terminals are tightened.

■ Refrigerant circuit

- Check for leaks inside the unit. In case a leak is detected, call your local dealer.
- Check the working pressure of the unit. Refer to paragraph "Switching the unit on" on page 8.

■ Compressor

- Check on oil leaks. If there is an oil leak, call your local dealer.
- Check for abnormal noises and vibrations. If the compressor is damaged, call your local dealer.

■ Water supply

- Check if the water connection is still well fixed.
- Check the water quality (refer to the installation manual of the unit for specifications of the water quality).

Disposal requirements

Dismantling of the unit, treatment of the refrigerant, of oil and of other parts must be done in accordance with relevant local and national legislation.

Saturated temperature

The figures below represent the average saturated temperature of R407C in relation to the pressure readout.

High pressure side

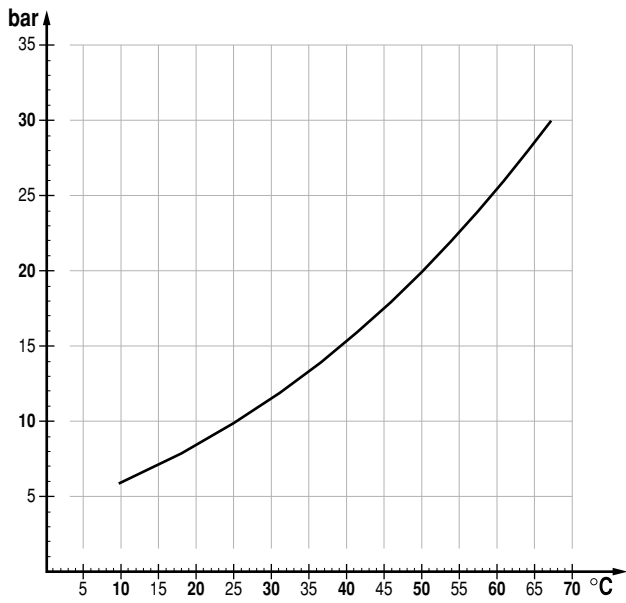

Low pressure side

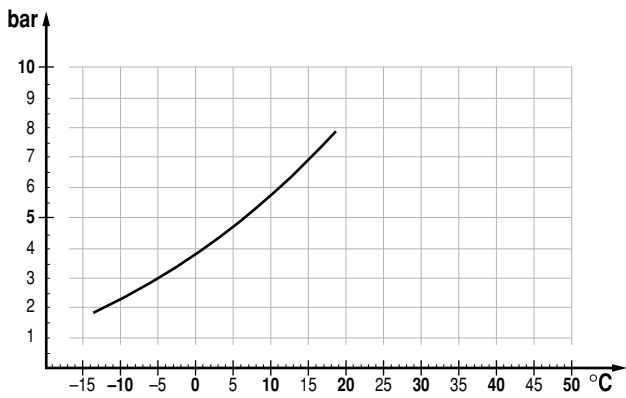

conditions:

- high pressure = 20 bar
- subcool = 3°C

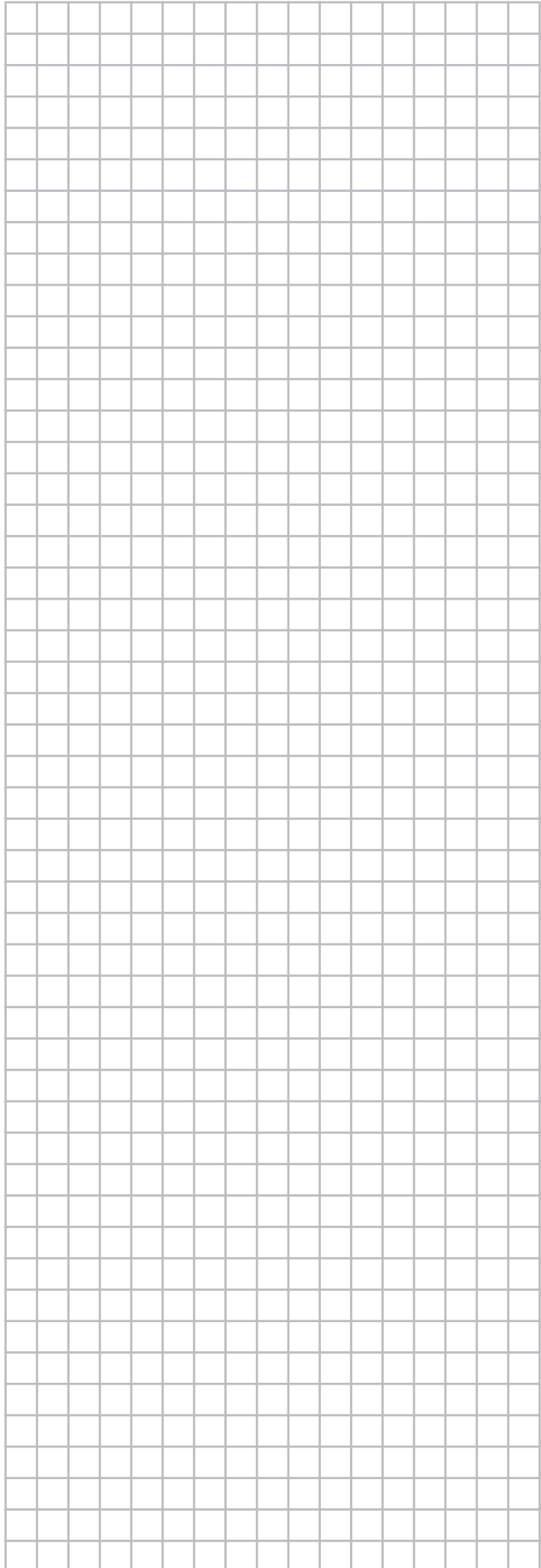

MENU OVERVIEW

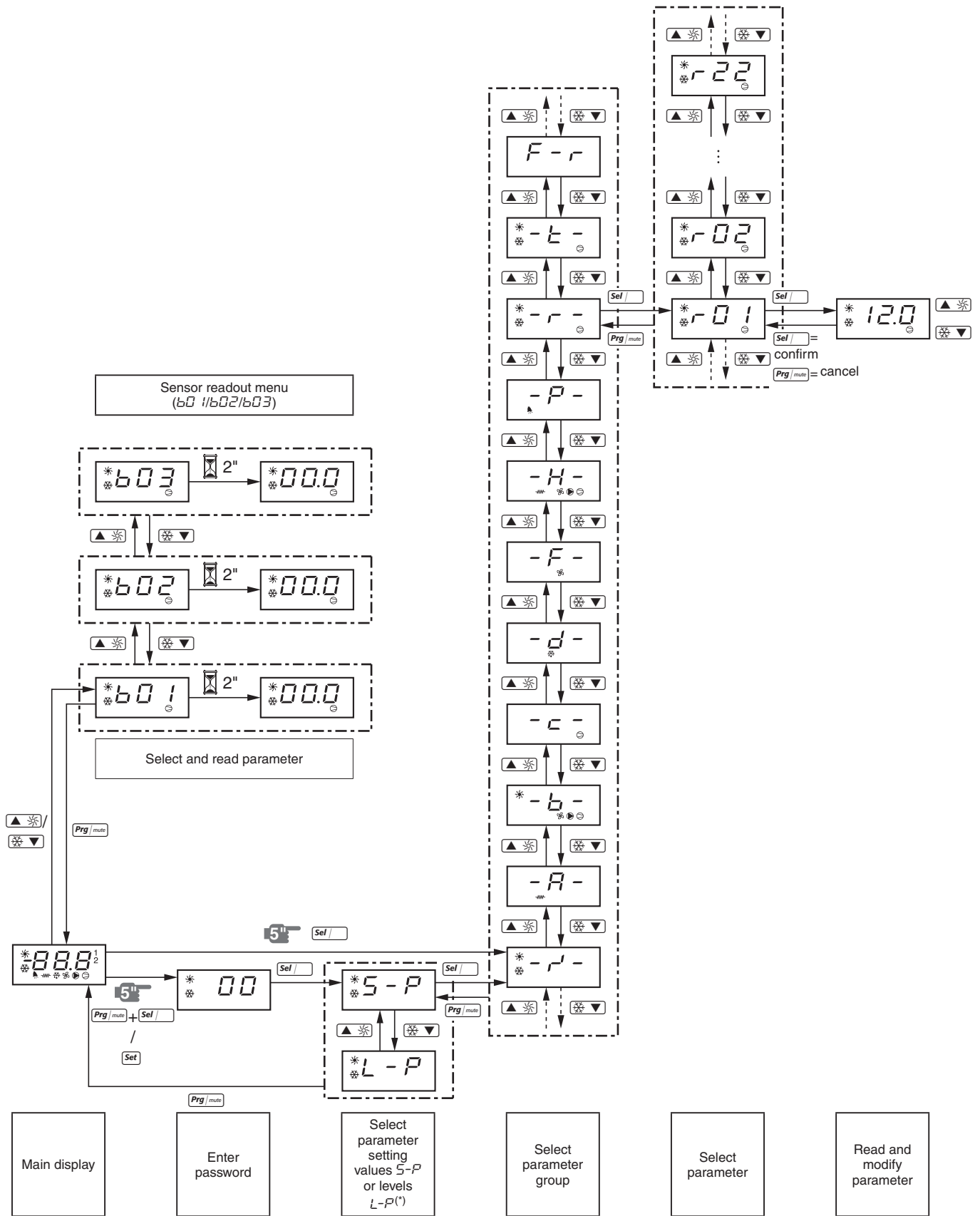

(*) L-P function is not used.



4PW61666-1 A 0000000R

Copyright 2010 Daikin

DAIKIN EUROPE N.V.

Zandvoordestraat 300, B-8400 Oostende, Belgium

4PW61666-1A 2012.04